

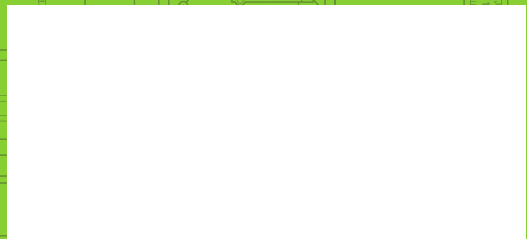

THE CATALOGUE

THE CATALOGUE FOR
MRO PROFESSIONALS
[MAINTENANCE,
REPAIR AND
OPERATIONS]

46





POWERTOOLS

p. 505



Cordless power tools

p. 513



Wire power tools



PNEUMATICS

p. 518



Staplers and brad nailers

p. 520



Air impact wrenches

p. 523



Air die grinders

p. 523



Air belt sander

p. 526



Air guns

p. 528



Spray guns

p. 531



Air hose reel



SOLDERING IRONS, PAINT STRIPPERS AND HEAT GLUE GUNS

p. 532



Solderings

p. 533



Hot air guns

p. 534



Glue guns



EQUIPMENT FOR LIQUIDS AND FLUIDS

p. 535



Oilers

p. 536



Greaser guns

p. 537



Spray

p. 540



Tanks

p. 540



Pressure sprayers

p. 541



Pumps



HEATERS, LIGHTING AND LENSES

p. 543



Heaters

p. 544



LED Lights

p. 545



Lamps

p. 547



Magnifier lens

p. 547



Battery operated torches and lamps

p. 551



Powers sockets



FERVI POWER TOOLS

Designed to take your work experience to the next level - easier, faster and more efficient. Thanks to cutting-edge technologies and high-quality materials, they are designed to last over time and offer exceptional performance.

POWER

Our power tools are equipped with powerful motors that will allow you to tackle even the most demanding challenges with ease.



MORE POWER

We have designed a wide range of tools to suit your specific needs, be it professional work, DIY or home maintenance. Our advanced technology ensures greater energy efficiency, thus helping to reduce energy consumption.



EXTRAPOWER

They are designed with your comfort in mind, with ergonomic handles and an intuitive design to reduce fatigue during use. Our range is built to resist wear and tear and ensure long life, so you can rely on them for many years to come.



A complete range consisting of the battery-powered line with 20 V platform - F20VRange - and the wired one to meet your application needs.

NEW

FB12CD3AS-22B

CORDLESS DRILL - SCREWDRIVER 12V

Automatic spindle lock, keyless self-tightening chuck, 21 clutch settings, step speed selection, electronic speed adjustment, variable torque, 2 modes: screwdriving and drilling, reverse rotation, quick charge, belt clip, built-in led light.

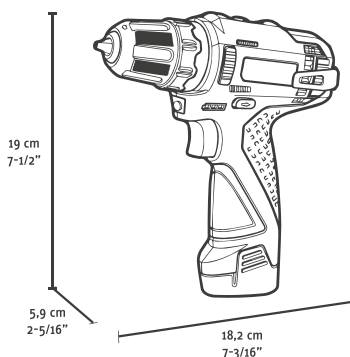

- Carrying case
- Brushless Motor
- Electronic Speed
- Keyless
- Variable Torque
- Speed Selector
- 2 Functions

No-load speed	0-380 min-1 / 0-1250 min-1	Drilling output wood	Max 28 mm
Chuck tightening range	0,8 - 10 mm	Max screw diameter	6 mm
Torque	19 / 30 Nm	Included batteries	2 x 2Ah, 12V
Drilling output steel	Max 10 mm	Included battery charger	2A, 12V



F20VRANGE



Impact drill / Screwdriver

Heavy rotary hammer

Cordless drill

Impact wrench

Work light

Impact screwdriver

Angle grinder



BATTERY



20V 2Ah



20V 4Ah



20V 2A



20V 4A

High performance brushless motor

The F20VRange range is made up of brushless motor tools with advanced technology that guarantees greater performance, longer life, lighter and more compact tools.

Optimized battery cells

The new professional lithium battery cells have a lower impedance which guarantees greater power. Our 20 V batteries have slow self-discharge which guarantees longer life and a reduced memory effect which guarantees longer life cycles.

The right range in the right place

An important range in constant growth, designed to tackle the most demanding applications.

2Ah, 4Ah

The 2 capacity levels allow you to choose the most suitable battery based on the type of work and duration of use.

2A, 4A

Our rapid chargers allow you to always be operational, optimizing your work.

FB20CD3AB-
NEW
CORDLESS DRILL - SCREWDRIVER 20V

Brushless motor, automatic spindle lock, keyless self-tightening chuck, 21 clutch settings, step speed selection, electronic speed adjustment, variable torque, 2 modes: screwdriving and drilling, reverse rotation, belt clip, built-in led light, effective motor cooling system.

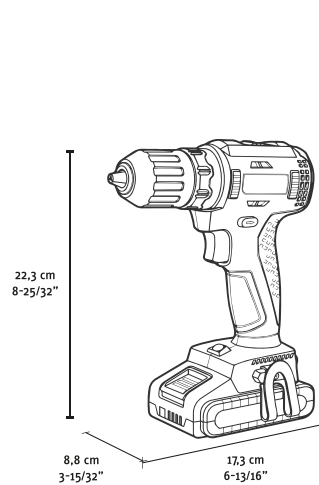

No-load speed	0-420 min-1 / 0-1400 min-1
Chuck tightening range	2 - 13 mm
Torque	35 / 55 Nm
Drilling output steel	Max 13 mm
Drilling output wood	Max 40 mm
Max screw diameter	8 mm



Art.	Batteries	Battery charger
FB20CD3AB-12B	1 x 2Ah, 20V	2A, 20V
FB20CD3AB-14B	1 x 4Ah, 20V	4A, 20V
FB20CD3AB-22B	2 x 2Ah, 20V	2A, 20V
FB20CD3AB-24B	2 x 4Ah, 20V	4A, 20V
FB20CD3AB-B	Not included	Not included

FB20ID3AB-
NEW
IMPACT DRILL - SCREWDRIVER 20 V

Brushless motor, automatic spindle lock, metal keyless self-tightening chuck, 21 clutch settings, step speed selection, electronic speed adjustment, variable torque, 3 modes: screwdriving / drilling / impact drilling, reverse rotation, belt clip, built-in led light, large air vents.

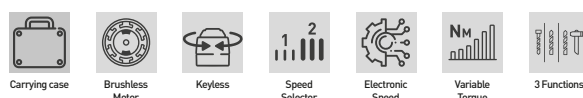
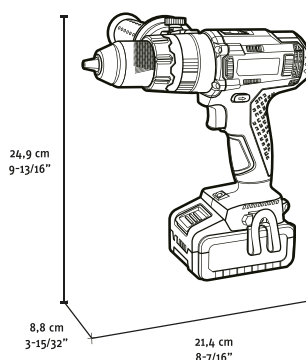

No-load speed	0-550 min-1 / 0-2000 min-1
Impact rate	0-7500 min-1 / 0-30000 min-1
Chuck tightening range	1,5 - 13 mm
Torque	70 / 75 Nm
Drilling output concrete	Max 16 mm
Drilling output steel	Max 13 mm
Drilling output wood	Max 40 mm
Max screw diameter	10 mm



Art.	Batteries	Battery charger
FB20ID3AB-12B	1 x 2Ah, 20V	2A, 20V
FB20ID3AB-14B	1 x 4Ah, 20V	4A, 20V
FB20ID3AB-22B	2 x 2Ah, 20V	2A, 20V
FB20ID3AB-24B	2 x 4Ah, 20V	4A, 20V
FB20ID3AB-B	Not included	Not included

FB20RH3AB-

NEW

HEAVY ROTARY HAMMER 20 V

Brushless motor, sds-plus chuck, rotation speed stabilization system at both an idle and under load, 3 modes: drilling / impact drilling / chiselling, vario-lock mode, anti-vibrations system, safety clutch to prevent motor damages and overloads, built-in led light, depth stop included.

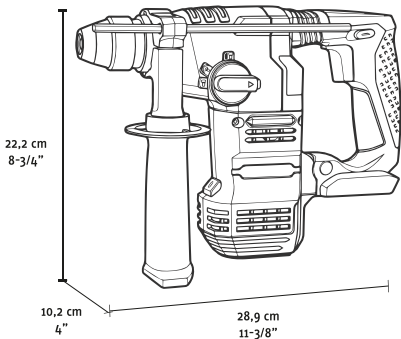

No-load speed	0-1400 min-1
Impact rate	0-4500 min-1
Chuck tightening range	2,3 J
Torque	SDS-Plus
Drilling output concrete	Max 18 mm
Drilling output steel	Max 13 mm
Drilling output wood	Max 20 mm
Max screw diameter	10 mm

Art.	Batteries	Battery charger
FB20RH3AB-24B	2 x 4Ah, 20V	4A, 20V
FB20RH3AB-B	Not included	Not included

FB20AG3AB-

NEW

ANGLE GRINDER 125 MM 20V

Brushless motor, soft start for increased safety of use, restart protection, two-position on/off switch with locking system, safety clutch to prevent motor damages and overloads, quick adjustable guard, soft rubber grip, metal dust filter on air intake, small size machine body, thick soft rubber anti-vibration grip, large air vents.

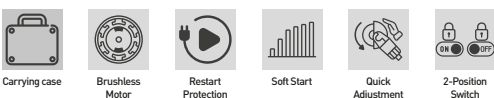
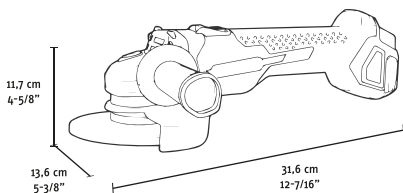

Speed	8000 min-1
Shank	M14
Max Ø of cutting disc	125 mm
Max Ø of grinding disc	125 mm
Max Ø of rubber sanding plate	125 mm
Max Ø of circular wire brush	75 mm
Max Ø of cup wire brush	75 mm

Art.	Batteries	Battery charger
FB20AG3AB-12B	1 x 2Ah, 20V	2A, 20V
FB20AG3AB-14B	1 x 4Ah, 20V	4A, 20V
FB20AG3AB-22B	2 x 2Ah, 20V	2A, 20V
FB20AG3AB-24B	2 x 4Ah, 20V	4A, 20V
FB20AG3AB-B	Not included	Not included

FB20IS3AB-K

NEW

IMPACT SCREWDRIVER 20V

Brushless motor, 1/4" hexagonal tool holder, electronic speed adjustment, step speed selection, reverse rotation, built-in led light (4 lights), belt clip, variable torque: 35 nm / 130 nm / 200 nm / 260 nm, additional anti-vibration hook for 4ah battery, magnesium head for better heat dissipation, efficient ventilation system for engine cooling.

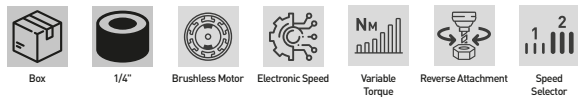

No-load speed	0-2100 min-1
Impact rate	0-3200 min-1
Torque	35 / 130 / 200 / 260 Nm
Tool holder	1/4" hex
Min - max bolt / nut Ø	M12 - M22
Batteries	Not included
Included battery charger	Not included

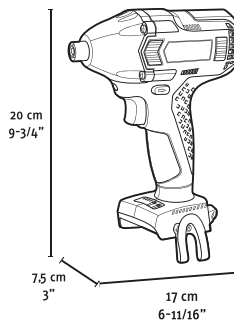

FB20IW3AB-K

NEW

IMPACT WRENCH 20V

Brushless motor, 1/2" square tool holder, electronic speed adjustment, step speed selection, reverse rotation, built-in led light (4 lights), belt clip, variable torque: 35 nm / 130 nm / 200 nm / 300 nm, additional anti-vibration hook for 4ah battery, magnesium head for better heat dissipation, efficient ventilation system for engine cooling.

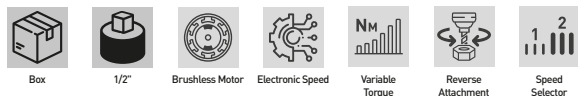

No-load speed	0-2100 min-1
Impact rate	0-3200 min-1
Torque	35 / 130 / 200 / 300 Nm
Tool holder	1/2" square
Min - max bolt / nut Ø	M12 - M22
Batteries	Not included
Battery charger	Not included

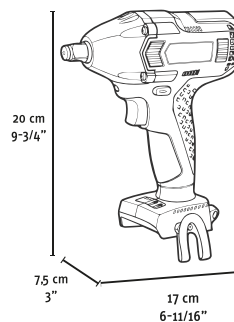

FB20LL3AX-K

NEW

WORK LIGHT 20V

270° swivel head, soft rubber grip, belt clip, luminous flux 250 lm.

- Box
- Soft Grip
- ~12h (2Ah) /
~24h (4Ah)
- Belt Hook
- 270°
- LI-ION
BATTERY

LED power	3 W
Luminous flux	250 lm
Autonomy	~12h (2Ah) / ~24h (4Ah)
Batteries	Not included
Battery charger	Not included

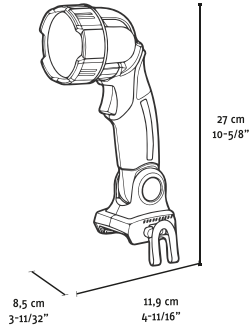



FB20BC3A2-K

NEW

BATTERY CHARGER 2A 20V

Compatible with Fervi FB20LB3A2 and FB20LB3A4 batteries.



Box

Power	55 W
Output voltage	20 V
Output current	2 A
Recharging time	60 min. (FB20LB3A2) / 120 min. (FB20LB3A4)

FB20BC3A4-K

NEW

CHARGER 4A 20V

Compatible with Fervi FB20LB3A2 and FB20LB3A4 batteries
Fan-powered ventilated quick charge.



Box

Power	100 W
Output voltage	18 - 20 V Max.
Output current	4 A
Recharging time	35 min. (FB20LB3A2) / 60 min. (FB20LB3A4)

FB20LB3A2-E

NEW

BATTERY 2AH 20V

Compatible with all items in the Fervi F20VRange line
Compatible with Fervi FB20BC3A2 and FB20BC3A4 chargers.



Blister

Battery type	Li-Ion
Voltage	20 V
Capacity	2 Ah
Recharging time	60 min. (FB20BC3A2) / 35 min (FB20BC3A4)

FB20LB3A4-E

NEW

BATTERY 4AH 20V

Compatible with all items in the Fervi F20VRange line
Compatible with Fervi FB20BC3A2 and FB20BC3A4 chargers.



Blister

Battery type	Li-Ion
Voltage	20 V
Capacity	4 Ah
Recharging time	120 min. (FB20BC3A2) / 60 min (FB20BC3A4)

F20VRANGE

Charging Times



FB20BC3A2-K
20V - 2Ah



FB20BC3A4-K
20V - 4Ah

FB20LB3A2-E
20V - 2Ah



60 minutes

35 minutes

FB20LB3A4-E
20V - 4Ah



120 minutes

60 minutes

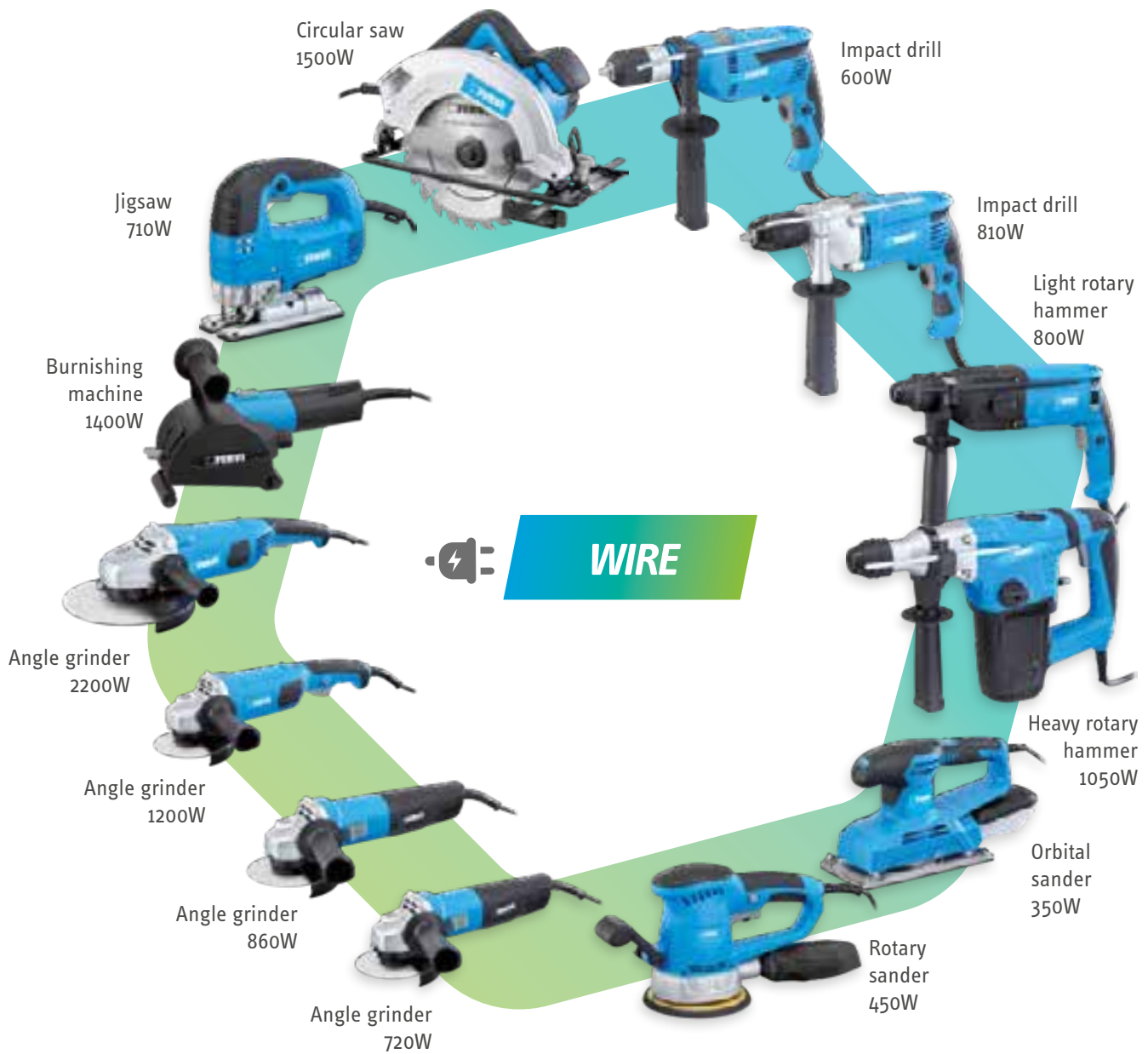

WIRE

High Price/Performance ratio

The wire line is equipped with high-performance motors equipped with on-board electronics for speed regulation, overheating management and gradual starting. This feature allows you to use a high-performance power tool at an incredible price.

Ergonomics and lightweight

The ergonomics and weight of the power tools have been designed to allow intensive use without burdening the operator.

Full line

When designing the wire line, we tried to accommodate all applications, also thinking about the materials to be processed.

For this reason, within the current offer you will find power tools for processing the following materials:

- **IRON**
- **STEEL**
- **ALUMINUM**
- **WOOD**
- **CEMENT**
- **CONCRETE**

FFID06003A-K
NEW
IMPACT DRILL 600W

2-Steps-lock keyless self-tightening chuck, variable speed, electronic speed adjustment, 2 modes: drilling / impact drilling, reverse rotation, lock-on function for increased comfort during extended work mode, non-slip soft rubber grip, depth stop and additional handle included.

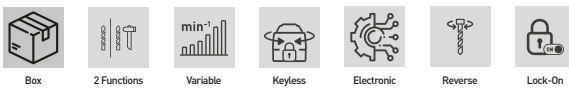
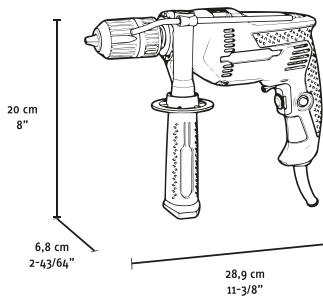

Power	600 W
Amperage at 220-230V	2,8 A
No-load speed	0-2800 min ⁻¹
Impact rate	0-44800 min ⁻¹
Chuck tightening range	2 - 13 mm
Drilling output concrete	Max 13 mm
Drilling output steel	Max 13 mm
Drilling output wood	Max 20 mm

FFID08103A-K
NEW
IMPACT DRILL 810W

Metal keyless self-tightening chuck, variable speed, electronic speed adjustment, 2 modes: drilling / impact drilling, reverse rotation, lock-on function for increased comfort during extended work mode, non-slip soft rubber grip, depth stop and additional handle included.

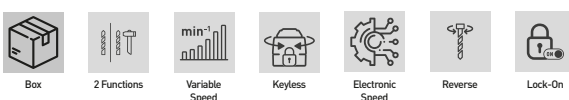
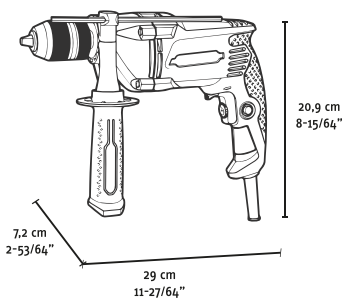

Power	810 W
Amperage at 220-230V	3,9 A
No-load speed	0-2800 min ⁻¹
Impact rate	0-44800 min ⁻¹
Chuck tightening range	2 - 13 mm
Drilling output concrete	Max 16 mm
Drilling output steel	Max 13 mm
Drilling output wood	Max 30 mm

FFRH08003A-B
NEW
LIGHT ROTARY HAMMER 800W

Sds-plus chuck, extra gear rim chuck with sds-plus adapter, electronic speed adjustment, 3 modes: drilling / impact drilling / chiselling, vario-lock mode, reverse rotation, safety clutch to prevent motor damages and overloads, lock-on function for increased comfort during extended work mode, soft rubber grip, depth stop, additional handle, 3 bits, pointed and flat chisels, additional chuck and flange wrench included.

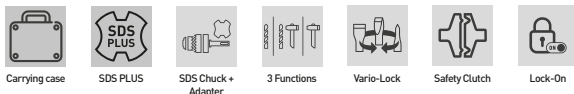
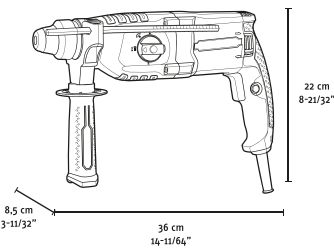

Power	800 W
Amperage at 220-230V	3,8 A
No-load speed	0-1200 min-1
Impact rate	0-5300 min-1
Test force	3,4 J
Chuck sizes	SDS-Plus
Drilling output concrete	Max 26 mm
Drilling output steel	Max 13 mm
Drilling output wood	Max 40 mm

FFRH10503A-B
NEW
HEAVY ROTARY HAMMER 1050W

Sds-plus chuck, electronic speed adjustment, 3 modes: drilling / impact drilling / chiselling, anti-vibrations system, safety clutch to prevent motor damages and overloads, soft rubber grip, depth stop, additional handle, 3 bits, pointed and flat chisels, dust collector, container with lubricant, flange wrench included.

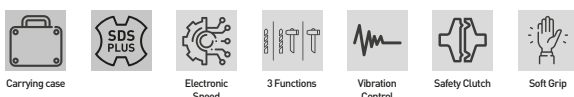
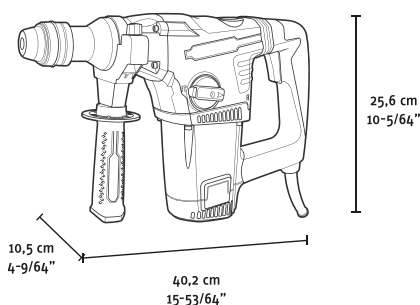

Power	1050 W
Amperage at 220-230V	4,9 A
No-load speed	0-750 min-1
Impact rate	0-2800 min-1
Test force	4,8 J
Chuck sizes	SDS-Plus
Drilling output concrete	Max 32 mm
Drilling output steel	Max 13 mm
Drilling output wood	Max 40 mm



FFAG07203A-115K
NEW
ANGLE GRINDER 115 MM 720W

M14 spindle thread, soft start, spindle lock, restart protection, two-position on/off slide switch with lock, small-size soft rubber grip, motor ecu to avoid rotor and stator overload, flange wrench, additional handle, protection guard included.



Power	720 W
Amperage at 220-230V	3,3 A
Speed	0-11000 min ⁻¹
Shank	M14
Max Ø of cutting disc	115 mm
Max Ø of grinding disc	115 mm
Max Ø of rubber sanding plate	115 mm
Max Ø of circular wire brush	75 mm
Max Ø of cup wire brush	75 mm

FFAG08603A-125K
NEW
ANGLE GRINDER 125 MM 860W

M14 spindle thread, soft start, spindle lock, restart protection, two-position on/off slide switch with lock, small-size soft rubber grip, motor ecu to avoid rotor and stator overload, flange wrench, additional handle, protection guard included.



Power	860 W
Amperage at 220-230V	3,9 A
Speed	0-11000 min ⁻¹
Shank	M14
Max Ø of cutting disc	125 mm
Max Ø of grinding disc	125 mm
Max Ø of rubber sanding plate	125 mm
Max Ø of circular wire brush	75 mm
Max Ø of cup wire brush	75 mm

FFAG12003V-125K
NEW
ANGLE GRINDER 125 MM 1200W

M14 spindle thread, soft start, variable speed, spindle lock, restart protection, lock-off function, small-size soft rubber grip, large air vents, quick-access carbon brush inspection compartment, flange wrench, additional handle, protection guard included.

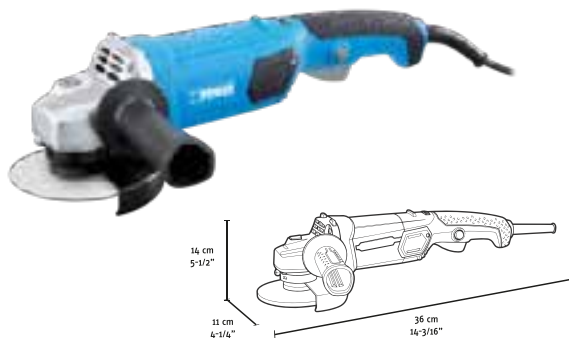

Power	1200 W
Amperage at 220-230V	5,4 A
Speed	0-11000 min ⁻¹
Shank	M14
Max Ø of cutting disc	125 mm
Max Ø of grinding disc	125 mm
Max Ø of rubber sanding plate	125 mm
Max Ø of circular wire brush	75 mm
Max Ø of cup wire brush	75 mm

FFAG22003A-230K
NEW
ANGLE GRINDER 230 MM 2200W

M14 spindle thread, soft start, spindle lock, restart protection, lock-off function, small-size soft rubber grip, motor ecu to avoid rotor and stator overload, 3-positions additional handle, large air vents and front airflow, 8 mm rubber cable, flange wrench, additional handle, protection guard included.

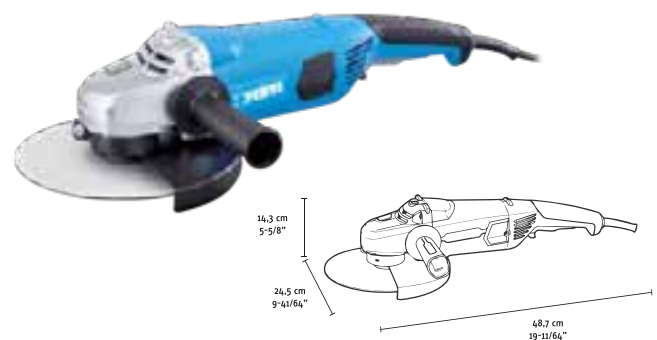

Power	2200 W
Amperage at 220-230V	10,0 A
Speed	0-6500 min ⁻¹
Shank	M14
Max Ø of cutting disc	230 mm
Max Ø of grinding disc	230 mm
Max Ø of rubber sanding plate	230 mm
Max Ø of circular wire brush	100 mm
Max Ø of cup wire brush	100 mm

FFSF14003A-110K
NEW
BURNISHING MACHINE 110 MM 1400W

Variable speed, rotation speed stabilization system at both an idle and under load, soft start, spindle lock, restart protection, two-position on/off switch with locking system, brush depth adjustment system with protective casing, additional handle, protective casing, vacuum cleaner adapter, allen key included.

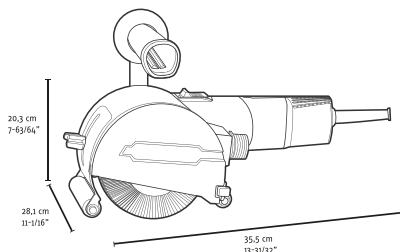
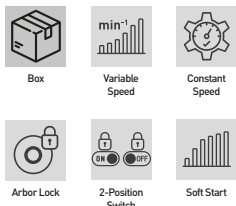

Power	1400 W
Amperage at 220-230V	6,6 A
Speed	1000-4000 min-1
Spindle diameter	19 mm
Max Ø of brush	110 mm
Max width of brush	100 mm

FFJS07103A-K
NEW
JIGSAW 710W

Stroke rate regulation, angular adjustment, 4-stage pendulum, saw blade quick change with blade defense, lock-on function, metal gears, front airflow for a cleaner cut, ideal for plunge cuts, saw blade, wing screw for guide bar, locating pin, allen key, guide for parallel / circle cutting included.

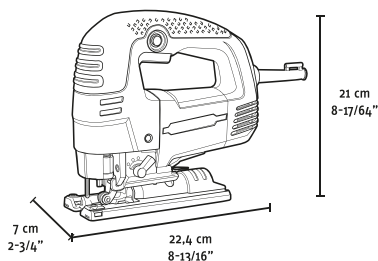
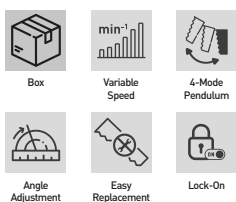

Power	710 W
Amperage at 220-230V	3,1 A
Stroke rate at no-load	700-3000 min-1
Stroke length	26 mm
Cutting depth in wood	85 mm
Cutting depth in aluminium	20 mm
Cutting depth in steel	10 mm
Cut range	Max 45° / 45°

FFCS15003A-190K
NEW
CIRCULAR SAW 1500W

Cutting depth adjustment, angular adjustment, lock-off function, dust extraction system with exhaust pipe, operator protection, soft rubber grip, blade, wrench, parallel guide included.

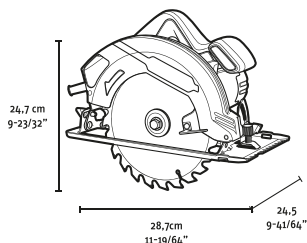
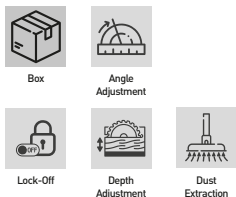

Power	1500 W
Amperage at 220-230V	6,8 A
No-load speed	5500 min-1
Min / max Ø blade	185 / 190 mm
Hole diameter	20 mm
Blade thickness	2 mm
Cutting Depth	Max 66 mm (90°) / 46 mm (45°)

FFOS03503A-K

NEW

ORBITAL SANDER 350W

Clamp-lever fixing system, variable speed, dust extraction system with container / compatible with vacuum cleaner, rear soft rubber d-handle, filter cleaning system, 3 pcs sandpaper and dust container included.

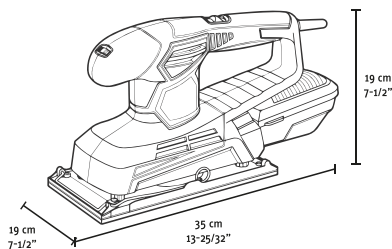
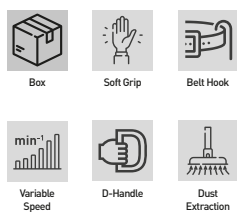

Power	350 W
Amperage at 220-230V	1,5 A
No-load speed	6000-11000 min-1
No-load oscillation rate	12000-22000 min-1
Eccentricity	2,5 mm
Sanding paper size	115 x 280 mm
Sanding surface size	115 x 230 mm

FFRS04503A-150K

NEW

ROTARY SANDER 150 MM 450W

Velcro fixing system, variable speed, lock-on function for increased comfort during extended work mode, dust extraction system with bag / compatible with vacuum cleaner, rear soft rubber d-handle, adjustable front handle, 3 pcs sandpaper (grit 60, 80, 120) and dust bag included.

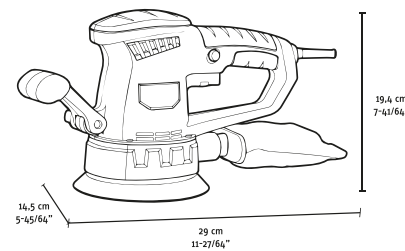
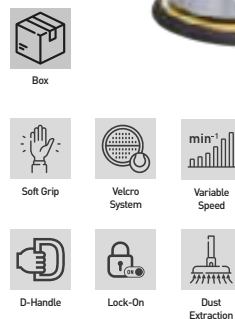

Power	450 W
Amperage at 220-230V	1,9 A
No-load speed	4000 min-1 / 13000 min-1
No-load oscillation rate	8000-26000 min-1
Eccentricity	2 mm
Sanding plate diameter	150 mm



0149

HEAVY DUTY STAPLE GUN TACKER

With 500 staples and 500 nails.



Blister

C586

AIR BRAD NAILER



Carrying case

Loader capacity	120
Working pressure	5 - 7 bar
Dimensions	260 x 240 x 65 mm
Nails	F - 10 / 50 mm
Air inlet	1/4"
Net weight	1,3 kg

F588/6

AIR BRADDER FOR MINI PINS



Carrying case

Loader capacity	195
Working pressure	5 - 7 bar
Dimensions	235 x 198 x 46 mm
Staples	0,60 - 12 / 25 mm
Air inlet	1/4"
Net weight	1 kg

F585

2 IN 1 AIR STAPLER AND BRAD NAILER



Carrying case

Loader capacity	100
Working pressure	5 - 7 bar
Dimensions	255 x 230 x 67 mm
Nails	F - 10 / 50 mm
Staples	90 - 10 / 40 mm
Air inlet	1/4"
Net weight	1,4 kg

O587

AIR STAPLER



Carrying case

Loader capacity	100
Working pressure	5 - 7 bar
Dimensions	225 x 165 x 45 mm
Staples	80 - 6 / 16 mm
Air inlet	1/4"
Net weight	0,9 kg

O585

2 IN 1 AIR STAPLER AND BRAD NAILER



Carrying case

Loader capacity	80
Working pressure	5 - 7 bar
Dimensions	245 x 230 x 55 mm
Nails	F - 10 / 50 mm
Staples	90 - 10 / 40 mm
Air inlet	1/4"
Net weight	1,4 kg



0586

AIR BRAD NAILER



Carrying case

Loader capacity	110
Working pressure	5 - 7 bar
Dimensions	245 x 225 x 55 mm
Nails	F - 10 / 50 mm
Air inlet	1/4"
Net weight	1,5 kg

0588/6

AIR BRADDER FOR MINI PINS



Carrying case

Loader capacity	130
Working pressure	5 - 7 bar
Dimensions	225 x 170 x 45 mm
Staples	0,60 - 12 / 30 mm
Air inlet	1/4"
Net weight	1 kg

C589

AIR PALM NAILER



Box

Working pressure	5 - 7 bar
Dimensions	111 x 115 x 70 mm
Nails	Ø 2.5 ÷ 4.1 - head Ø 6.3 ÷ 8.7 - length 38 ÷ 90 mm
Air inlet	1/4"
Net weight	0,5 kg



AP01

AIR IMPACT WRENCH

Professional series. In composite material, handle and head in shockproof rubber. Operating lever, change of rotation and speed adjustment operated with one hand. High power and great reliability.



Speed	8500 rpm
Torque	542 Nm 400 lb-ft
Avg air cons.	108 l/min 3.8 SCFM
Working pressure	6 bar 90 psi
Air inlet	1/4"
Net weight	1,2 kg

AP02

AIR IMPACT WRENCH

Professional series. In composite material, handle and head in shockproof rubber. Operating lever, change of rotation and speed adjustment operated with one hand. High power and great reliability.

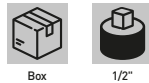

Speed	7800 rpm
Torque	678 Nm 500 lb-ft
Avg air cons.	136 l/min 4.8 SCFM
Working pressure	6 bar 90 psi
Air inlet	1/4"
Net weight	1,2 kg

AP03

AIR IMPACT WRENCH

Professional series. In composite material, handle and head in shockproof rubber. Operating lever, change of rotation and speed adjustment operated with one hand. High power and great reliability.



Speed	7300 rpm
Torque	1085 Nm 800 lb-ft
Avg air cons.	153 l/min 5.4 SCFM
Working pressure	6 bar 90 psi
Air inlet	1/4"
Net weight	2 kg

AP04

AIR IMPACT WRENCH

Professional series. In composite material, handle and head in shockproof rubber. Operating lever, change of rotation and speed adjustment operated with one hand. High power and great reliability.

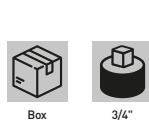

Speed	7300 rpm
Torque	1085 Nm 800 lb-ft
Avg air cons.	153 l/min 5.4 SCFM
Working pressure	6 bar 90 psi
Air inlet	1/4"
Net weight	2,1 kg



AP05

AIR IMPACT WRENCH

Professional series. In composite material, handle and head in shockproof rubber. Operating lever, change of rotation and speed adjustment operated with one hand. High power and great reliability.

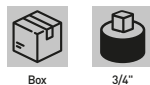

Speed	5300 rpm
Torque	1900 Nm 1400 lb-ft
Avg air cons.	224 l/min 8.1 SCFM
Working pressure	6 bar 90 psi
Air inlet	3/8"
Net weight	3,3 kg

AP05/150

AIR IMPACT WRENCH

With 150 mm Anvil professional series. In composite material, handle and head in shockproof rubber. Operating lever, change of rotation and speed adjustment operated with one hand. High power and great reliability.

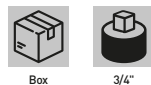
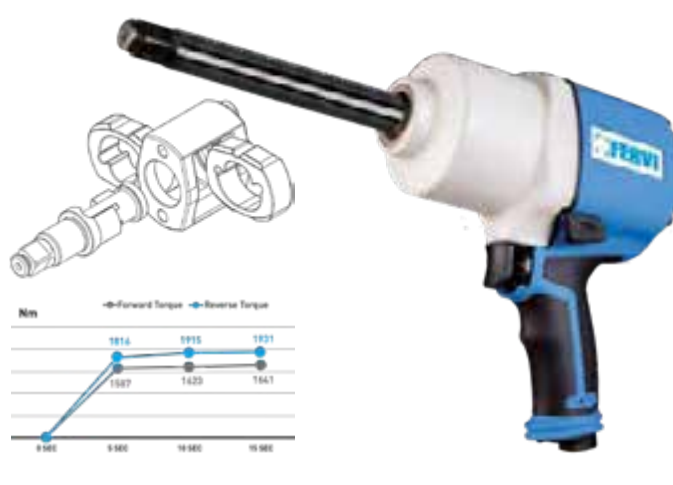

Speed	5300 rpm
Torque	1900 Nm 1400 lb-ft
Avg air cons.	224 l/min 8.1 SCFM
Working pressure	6 bar 90 psi
Air inlet	3/8"
Net weight	4 kg

AP06

AIR IMPACT WRENCH

Professional series. In composite material, handle and head in shockproof rubber. Operating lever, change of rotation and speed adjustment operated with one hand. High power and great reliability.

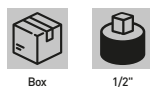

Speed	9000 rpm
Torque	312 Nm 230 lb-ft
Avg air cons.	113 l/min 4 SCFM
Working pressure	6 bar 90 psi
Air inlet	1/4"
Net weight	1,1 kg



0571

AIR IMPACT WRENCH



Speed	7000 rpm
Torque	610 Nm
Avg air cons.	5 SCFM (150 l/min)
Working pressure	6 bar / 90 psi
Air inlet	1/4"
Net weight	2,6 kg

0576

AIR IMPACT WRENCH



Speed	7000 rpm
Torque	435 Nm
Avg air cons.	5 SCFM (150 l/min)
Working pressure	6 bar / 90 psi
Shank	1/4"
Net weight	2,5 kg

0786

AIR IMPACT WRENCH



Speed	4200 rpm
Torque	950 Nm
Avg air cons.	8 SCFM (240 l/min)
Working pressure	6 bar / 90 psi
Air inlet	1/4"
Net weight	4,8 kg

0044

AIR IMPACT WRENCH SET

With 10 wrenches, a wrench extension, 1/4" nozzle.



Speed	7000 rpm	Working pressure	6 bar/90 psi
Torque	320 Nm	Sound pressure level	84,4 ± 2,94 dB(A)
Socket	9-10-11-13-14-17-19-22-24-27 mm	Level vibration transmitted to hand-arm	8.53 ± 2.05 m/s ²
Extension	125 mm	Air inlet	1/4"
Avg air cons.	5 SCFM (150 l/min)	Net weight	4 kg

0045

AIR IMPACT WRENCH



Speed	7000 rpm
Torque	320 Nm
Avg air cons.	5 SCFM (150 l/min)
Working pressure	6 bar / 90 psi
Air inlet	1/4"
Net weight	2,3 kg

0052

AIR IMPACT WRENCH



Speed	4800 rpm
Torque	680 Nm
Avg air cons.	6 SCFM (180 l/min)
Working pressure	6 bar / 90 psi
Air inlet	1/4"
Net weight	4,7 kg

0413

MINI AIR DIE GRINDER

Collet 3 mm and 6 mm. Revolving rear air outlet. Body frame made from composite material.



Box

Pliers	ø 3 mm - ø 6 mm
Speed	25000 rpm
Avg air cons.	4 SCFM (113 l/min)
Working pressure	6 bar / 90 psi
Air inlet	1/4"
Net weight	0,4 kg

0416

90° AIR DIE GRINDER

Collet Ø 3 mm - Ø 6 mm. Revolving rear air outlet.



Box

Pliers	ø 3 mm - ø 6 mm
Speed	20000 rpm
Avg air cons.	4 SCFM (113 l/min)
Working pressure	6 bar / 90 psi
Air inlet	1/4"
Net weight	0,5 kg

0418

REVERSIBLE AIR DRILL

Chuck 10 Ø mm , with rear exhaust 360°, composite body design.



Box

Chuck sizes	Ø 10 mm
Speed	1800 rpm
Avg air cons.	4 SCFM (113 l/min)
Working pressure	6 bar / 90 psi
Air inlet	1/4"
Net weight	0,9 kg

0414

AIR DIE GRINDER

3 mm and 6 mm, with rear exhaust 360°, exclusive composite body design.



Box

Pliers	ø 3 mm - ø 6 mm
Speed	22000 rpm
Avg air cons.	7 SCFM (198 l/min)
Working pressure	6 bar / 90 psi
Air inlet	1/4"
Net weight	0,6 kg

0417

LONG TYPE AIR DIE GRINDER

3 and 6 mm pincers, with rear exhaust 360°, exclusive composite body design.



Box

Pliers	ø 3 mm - ø 6 mm
Length	295 mm
Speed	20000 rpm
Avg air cons.	4 SCFM (113 l/min)
Working pressure	6 bar / 90 psi
Air inlet	1/4"
Net weight	0,6 kg

0419

6" AIR ORBIT SANDER WITH SUCTION

And speed control, hook & loop pad, 360° rear exhaust, die cast aluminum body with soft handle grip in lightweight and ergonomic design.



Box

Disc diameter	150 mm - 6"
Orbit	5 mm, 3/16"
Speed	10500 rpm MAX.
Avg air cons.	3 SCFM (85 l/min)
Working pressure	6 bar / 90 psi
Air inlet	1/4"
Length	200 mm
Net weight	1 kg

0421
6" AIR ORBIT SANDER WITH SELF-INTEGRATED SUCTION

Speed control, hook & loop pad, 360° rear exhaust, die cast aluminum body with soft handle grip in lightweight and ergonomic design, corrugated hose and dust bag.



Box

Disc diameter	150 mm - 6"
Orbit	5 mm, 3/16"
Speed	10500 rpm
Avg air cons.	3 SCFM (85 l/min)
Working pressure	6 bar / 90 psi
Air inlet	1/4"
Length	200 mm
Net weight	1 kg

0460
6" AIR ORBIT SANDER WITH SELF-INTEGRATED SUCTION

Speed adjustable, revolving rear air outlet, aluminum body, soft and ergonomic handle, Suction tube and dust collection bag.



Box

Disc diameter	150 mm - 6"
Orbit	2,5 mm - 3 / 32"
Max speed	10500 rpm
Avg air cons.	3 SCFM (85 l/min)
Working pressure	6 bar / 90 psi
Air inlet	1/4"
Length	200 mm
Net weight	1 kg

0047
REVERSIBLE AIR SCREWDRIVER

Box



1/4"

Speed	9000 rpm
Screw	4-5 mm
Torque	2,3 - 6,8 Nm
Length	180 mm
Avg air cons.	5 SCFM (150 l/min.)
Working pressure	6 bar / 90 psi
Air inlet	1/4"
Net weight	0,8 kg

0458
6" AIR ORBIT SANDER WITH SUCTION

Speed control, 2.5 mm orbit, hook & loop pad, 360° rear exhaust, die cast aluminum body with soft handle grip in lightweight and ergonomic design.



Box

Disc diameter	150 mm - 6"
Orbit	2,38 mm - 3 / 32"
Max speed	10500 rpm
Avg air cons.	3 SCFM (85 l/min)
Working pressure	6 bar / 90 psi
Air inlet	1/4"
Length	200 mm
Net weight	1 kg

0046
AIR RATCHET WRENCH SET

With 7 sockets, a fixed 75 mm extension for sockets, a 75 mm extension with joint for sockets, 1/4" nozzle, three screwdriver bits and a fixed 75 mm extension for screwdriver bits.



16 Pcs



Carrying case



1/2"

Speed	160 rpm
Torque	65 Nm
Socket	9-10-11-13-14-17-19 mm
Extension	75 mm
Universal joint	1/2"
Bit holder	1/4"
Avg air cons.	4 SCFM (120 l/min.)
Working pressure	6 bar / 90 psi
Air inlet	1/4"
Net weight	2,6 kg

0339
REVERSIBLE AIR DRILL

Box

Chuck sizes	Ø 10 mm
Speed	1800 rpm
Avg air cons.	5 SCFM (150 l/min.)
Working pressure	6 bar / 90 psi
Air inlet	1/4"
Net weight	1,1 kg



0574

REVERSIBLE AIR DRILL



Box

Chuck sizes	Ø 10 mm
Speed	1800 rpm
Avg air cons.	5 SCFM (150 l/min)
Working pressure	6 bar / 90 psi
Air inlet	1/4"
Net weight	1 kg

0313

5" AIR ANGLE DIE GRINDER



Box

Saw blade	Ø 125 mm
Speed	10000 rpm
Avg air cons.	5 SCFM (150 l/min)
Working pressure	6 bar / 90 psi
Air inlet	1/4"
Net weight	2 kg

0050

AIR DIE GRINDER SET



13 Pcs



Carrying case

Pliers	Ø 3 mm - Ø 6 mm	Working pressure	6 bar / 90 psi
Mounted stone	10 Pcs / Pcs	Air inlet	1/4"
Speed	22000 rpm	Net weight	1,2 kg
Avg air cons.	4 SCFM (120 l/min.)		

0051

AIR DIE GRINDER



Box

Pliers	Ø 3 mm - Ø 6 mm
Speed	22000 rpm
Avg air cons.	4 SCFM (120 l/min.)
Working pressure	6 bar / 90 psi
Air inlet	1/4"
Net weight	0,8 kg

0570

AIR DIE GRINDER SET

With 10 clips, 2 pliers, 1 nozzle for connecting the feeding tube.



14 Pcs



Carrying case

Pliers	Ø 3 mm - Ø 6 mm
Mounted stone	10 Pcs
Speed	21000 rpm
Power	0,45 hp
Avg air cons.	5 SCFM (150 l/min.)
Working pressure	6 bar / 90 psi
Sound pressure emitted in atmosphere	77.9 ± 3.0 dB(A)
Air inlet	1/4"
Net weight	1 kg

0115

AIR DIE GRINDER



Box

Pliers	Ø 3 mm - Ø 6 mm
Speed	20000 rpm
Length	295 mm
Avg air cons.	4 SCFM (120 l/min.)
Working pressure	6 bar / 90 psi
Air inlet	1/4"
Net weight	0,7 kg

0641

FLEXIBLE PNEUMATIC MICROGRINDING WHEEL

For grinding and chamfering



Collet capacity	3 mm
Speed	56000 rpm
Avg air cons.	2 SCFM (60 l/min.)
Working pressure	6 bar / 90 psi
Air inlet	1/4"
Net weight	0,7 kg



0644

PNEUMATIC AXIAL GRINDING WHEEL



Saw blade	Ø 75 x 1,5 x Ø 10 mm	Working pressure	6 bar / 90 psi
Speed	15000 rpm	Air inlet	1/4"
Avg air cons.	5 SCFM (150 l/min.)	Net weight	0,7 kg



0049

OILER

For pneumatic tools.



W021PG

TYRE INFLATING GUN



Max. pressure	12 bar (170 psi)
Working pressure	2 - 4 bar (30 - 60 psi)
Accuracy	±1%
Rubber hose length	440 mm
Air inlet	1/4"



0784

AIR BELT SANDER

With spare belts. Light metal body.



Speed	16000 rpm	Belt	10 x 330 mm
Avg air cons.	6 SCFM (180 l/min.)	Air inlet	1/4"
Working pressure	6 bar / 90 psi	Net weight	0,9 kg



0059

HEAVY DUTY AIR HAMMER WITH 4 HEXAGONAL CHISELS

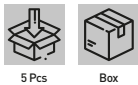

Speed	BPM 3500	Working pressure	6 bar / 90 psi
Bore-stroke	19 x 66 mm / 3/4" x 2 5/8"	Air inlet	1/4"
Avg air cons.	4,5 SCFM (135 l/min)	Net weight	1,5 kg



W021PA

BLOW GUN



Nozzle	2.0 mm
Working pressure	2 - 6 bar
Air inlet	1/4"



W021PN

WASHING GUN

With aluminium body and steel cup.



Capacity	900 ml
Nozzle	4.5 mm
Working pressure	3 - 4 bar
Air inlet	1/4"





0607

BLOW GUN



Alu

Blister Aluminum

Nozzle	2.0 mm
Working pressure	4-6 bar
Air inlet	1/4"



0125

DIGITAL TYRE GAUGE

With backlight and various measurement units. Equipped with tyre valve screwdriver.



Blister

Max. pressure	8 bar (110 psi)
Working pressure	2 - 4 bar (30 - 60 psi)
Reading	0,05 bar 0,7 psi
Not included batteries	2 x 1.5V AAA
Air inlet	1/4"



0608

TYRE INFLATING GUN



Blister

Manometer	ø 63 mm
Reading	0÷12 bar 0÷174 psi
Rubber hose length	420 mm
Air inlet	German-type rapid



0610

WASHING GUN



Box

Capacity	1000 ml
Air inlet	1/4"



0609

TYRE INFLATING GUN



Blister

Manometer	ø 70 mm
Reading	0÷12 bar 0÷174 psi
Rubber hose length	1000 mm
Air inlet	1/4"



0725

BLOW GUN



Blister

Hose length	100 mm
Air inlet	1/4"



UPGRADE

0725L

LONG NOSE BLOW GUN



Blister

Hose length	275 mm
Air inlet	1/4"



UPGRADE

0412

BLOW GUN

High quality, with chromed steel 100 mm nozzle gun body in POM plastic (Polyoxymethylene) brass valve.



Blister

Hose length	100 mm
Air inlet	1/4"



TH601A
GRAVITY FEED SPRAY GUN

600ml feed HVLP spray gun, nylon gravity cup, made with CNC machine, without O-ring, with stainless steel nozzle and needle, brass air cap, alum clamp and knobs. HVLP = high volume, low pressure.



Box

INOX

Chromed



Capacity	600 ml
Nozzle diameter	1,3 mm
Fluid delivery	130 ml/min
Working pressure	2 bar (29 PSI)
Working range	200 mm
Pattern	280 - 300 mm
Air inlet	1/4"
Net weight	0,5 kg

TH602A
GRAVITY FEED SPRAY GUN

100ml feed HVLP spray gun, nylon gravity cup, made with CNC machine, without O-ring, with stainless steel nozzle and needle, brass air cap, alum clamp and knobs, male thread fitting 1/4" HVLP = high volume, low pressure.



Box

INOX

Chromed



Capacity	100 ml
Nozzle diameter	1,0 mm
Fluid delivery	50 ml/min
Working pressure	1,5 bar (20 PSI)
Working range	150 mm
Pattern	160 mm
Air inlet	1/4"
Net weight	0,3 kg

TH901A
GRAVITY FEED SPRAY GUN

600ml feed LVMP spray gun, nylon gravity cup, made with CNC machine, without O-ring, with stainless steel nozzle and needle, brass air cap, alum clamp and knobs. LVMP = low volume, medium pressure.



Box

INOX

Chromed



Capacity	600 ml
Nozzle diameter	1,3 mm
Fluid delivery	140 ml/min
Working pressure	2 ÷ 2,2 bar (29 ÷ 32 PSI)
Working range	200 mm
Pattern	270 - 300 mm
Air inlet	1/4"
Net weight	0,5 kg

A601DS
SUCTION SPRAY GUN

1000ml suction HVLP spray gun with baionet lock, aluminum cup, made with CNC machine, without O-ring, with stainless steel nozzle and needle brass air cap, alum clamp and knobs. HVLP = high volume, low pressure.



Box

INOX

Chromed



Nozzle	Ø 1,4 mm
Capacity	1000 cc
Working pressure	2,5 - 3 bar
Air inlet	1/4"
Net weight	1,1 kg

A601A
GRAVITY FEED SPRAY GUN

600ml feed HVLP spray gun, nylon gravity cup, made with CNC machine, without O-ring, with stainless steel nozzle and needle brass air cap, blue color alum clamp and knobs. HVLP = high volume, low pressure.



Box

INOX

Chromed



Nozzle	Ø 1,4 mm
Capacity	600 cc
Working pressure	2,5 - 3,5 bar
Air inlet	1/4"
Net weight	1 kg

A602A
GRAVITY FEED SPRAY GUN

100ml feed HVLP spray gun, nylon gravity cup, made with CNC machine, without O-ring, with stainless steel nozzle and needle brass air cap, blue color alum clamp and knobs. HVLP = high volume, low pressure.



Box

INOX

Chromed



Nozzle	Ø 1,0 mm
Capacity	100 cc
Working pressure	2 - 2,5 bar
Air inlet	1/4"
Net weight	0,5 kg



A901A

GRAVITY FEED SPRAY GUN

600ml feed LVMP spray gun, nylon gravity cup, made with CNC machine, without O-ring, with stainless steel nozzle and needle, brass air cap, blue color alum clamp and knobs. LVMP = low volume, medium pressure.



INOX



Capacity	600 ml
Nozzle diameter	1,4 mm
Fluid delivery	200-380 ml/min
Max. pressure	2-3 bar (30-43 PSI)
Air inlet	1/4"
Net weight	0,6 kg

A902A

GRAVITY FEED SPRAY GUN

100ml feed LVMP spray gun, nylon gravity cup, made with CNC machine, without O-ring, with stainless steel nozzle and needle brass air cap, blue color alum clamp and knobs. 1/4" LVMP = low volume, medium pressure.



INOX



Capacity	100 ml
Nozzle diameter	1 mm
Fluid delivery	45 - 65 ml/min
Max. pressure	1.5 - 2.5 bar (22 - 36 PSI)
Air inlet	1/4"
Net weight	0,3 kg

A162DS

SPRAY GUN WITH FLUID CUP PROVIDED WITH BAYONET LOCK

Aluminum cover.



Alu

Aluminum



Nozzle	Ø 1,8 mm
Capacity	1000 cc
Working pressure	4-8 bar
Air consumption	100-200 l/min
Air inlet	1/4"
Net weight	0,9 kg

A162C

SPRAY GUN WITH FLUID CUP PROVIDED WITH RAPID LOCK

Aluminum cover



Alu

Aluminum



Nozzle	Ø 1,8 mm
Capacity	1000 cc
Working pressure	4-8 bar
Air consumption	100-200 l/min
Air inlet	1/4"
Net weight	0,8 kg

A162A

SPRAY GUN WITH GRAVITY FLOW CUP



Box



Nozzle	Ø 1,8 mm
Capacity	500 cc
Working pressure	4-8 bar
Air consumption	100-200 l/min
Net weight	0,5 kg

0048

MINI SPRAY GUN

Fitting for pressurized air container and 1/4" fitting for air compressor.



7 Pcs



Box

TH250
PRESSURE REGULATOR

With gauge for air tools.



Blister

Manometer	ø 40 mm
Reading	0÷11 bar 0÷160 psi

TH500
PRESSURE REGULATOR

With gauge for air tools.



Blister

Manometer	ø 30 mm
Reading	0÷10 bar 0÷145 psi

0777/2
REDUCER WITH GAUGE AND FILTER

Box

Shank	1/4" - 3/8" - 1/2"
Reading	0÷10 bar 0÷140 psi

0777/3
REDUCER WITH GAUGE, FILTER AND OILER

Box

Shank	1/4" - 3/8" - 1/2"
Reading	0÷10 bar 0÷140 psi

0785-XM
SET 2 PCS UNIVERSAL MALE QUICK COUPLER

Art.	Shank
0785/1M	1/4"
0785/2M	3/8"

0785-XF
SET 2 PCS UNIVERSAL FEMALE QUICK COUPLER

Art.	Shank
0785/1F	1/4"
0785/2F	3/8"

0783-XM
SET 2 PCS OF GERMAN TYPE MALE PLUG

Art.	Shank
0783/1M	1/4"
0783/2M	3/8"

0783-XF
2 PCS SET GERMAN TYPE FEMALE PLUG

Art.	Shank
0783/1F	1/4"
0783/2F	3/8"

S075-
POLYURETHANE SPIRAL HOSE WITH SWIVEL MALE FITTING

Art.	Length	Diameter	Thread
S075/08X5	7,5 m	Ø 8 x 5 mm	1/4"
S075/10X6.5	7,5 m	Ø 10 x 6,5 mm	1/4"
S100/08X5	10 m	Ø 8 x 5 mm	1/4"
S100/10X6.5	10 m	Ø 10 x 6,5 mm	1/4"
S100/12X8	10 m	Ø 12 x 8 mm	1/4"





A481/10

AUTO REWIND AIR HOSE REEL

Made of polypropylene shell, with polyurethane mesh hose and regulation for distributing evenly the tube in the internal part, tools free adjustable stop ball and 180° swivel mount bracket.

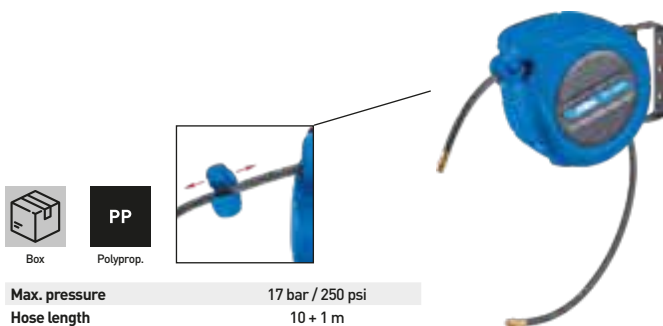

Max. pressure	17 bar / 250 psi
Hose length	10 + 1 m
Male Fitting	1/4" BSPT
Hose diameter	ø 12 x 8 mm
Working temperature	0 ÷ 45° C
Net weight	2,9 kg

A481/15

AUTO REWIND AIR HOSE REEL

Made of polypropylene shell, with polyurethane mesh hose and regulation for distributing evenly the tube in the internal part, tools free adjustable stop ball and 180° swivel mount bracket.

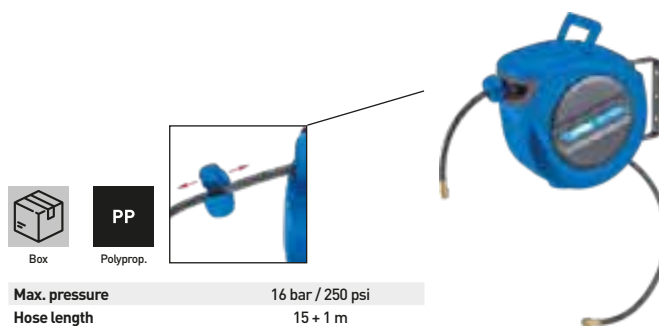

Max. pressure	16 bar / 250 psi
Hose length	15 + 1 m
Male Fitting	1/4" BSPT
Hose diameter	ø 12 x 8 mm
Working temperature	0 ÷ 45° C
Net weight	4,4 kg

A481/15H

AUTO REWIND AIR HOSE REEL

Made of polypropylene shell, with polyurethane mesh hose and regulation for distributing evenly the tube in the internal part, tools free adjustable stop ball and 180° swivel mount bracket.

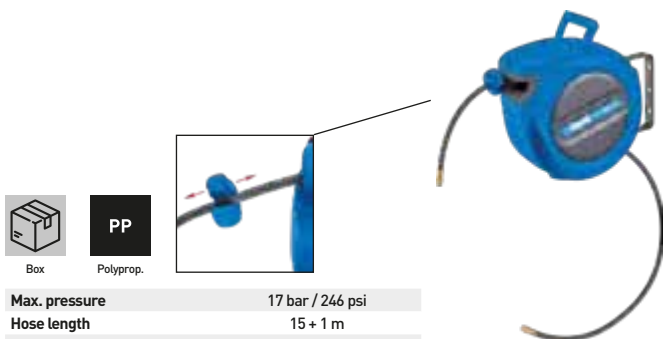

Max. pressure	17 bar / 246 psi
Hose length	15 + 1 m
Male Fitting	3/8" BSPT
Hose diameter	ø 13.5 x 9.5 mm
Working temperature	0 ÷ 45° C
Net weight	4,5 kg

A481/30H

AUTO REWIND AIR HOSE REEL

Made of polypropylene shell, with polyurethane mesh hose and regulation for distributing evenly the tube in the internal part, tools free adjustable stop ball, low speed retraction system and 180° swivel mount bracket.

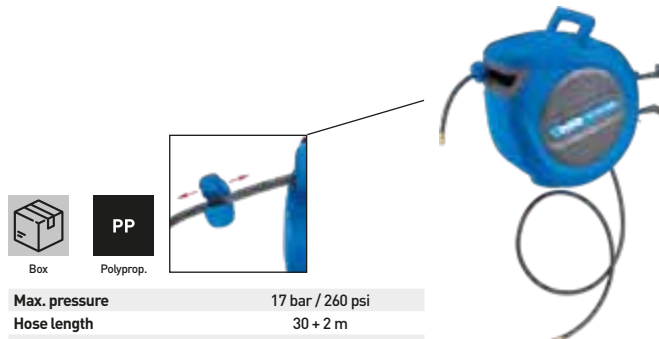

Max. pressure	17 bar / 260 psi
Hose length	30 + 2 m
Male Fitting	3/8" BSPT
Hose diameter	ø 13.5 x 9.5 mm
Working temperature	0 ÷ 45° C
Net weight	9 kg

0378/1510

AUTO REWIND AIR HOSE REEL

With pu mesh hose and regulation for distributing evenly the tube in the internal part.

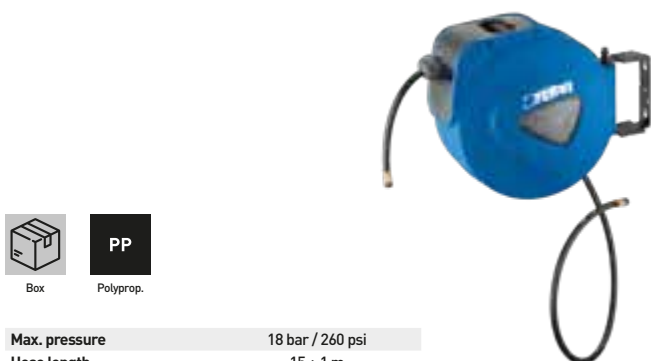

Max. pressure	18 bar / 260 psi
Hose length	15 + 1 m
Male Fitting	3/8" BSPT
Hose diameter	ø 13,5 x 9,5 mm
Working temperature	0 ÷ 45° C
Net weight	5 kg

0481/15

AUTO REWIND AIR HOSE REEL

With pu mesh hose, german type female quick coupler, german type female plug and regulation for distributing evenly the tube in the internal part.



Max. pressure	16 bar / 250 psi
Hose length	15 + 1 m
Male Fitting	1/4" BSPT
Hose diameter	ø 12 x 8 mm
Working temperature	0 ÷ 45° C
Net weight	4,5 kg



0793

WOOD-BURNING PEN SET WITH 6 PINS OF DIFFERENT SHAPE



Power 230 V 50 Hz 30 W

0031

HIGH PRECISION TEMPERATURE -CONTROLLED SOLDERING IRON STATION

Adjustable temperature 150°C - 420°C, iron tip with hole ø 6 mm.



Melting point	215°
Working temperature	215 ÷ 300°C
Max temperature	450°C
Power	230 V, 50 Hz, 37 W

0027/40W

SOLDERING IRON



Power	230 V 50 Hz 40 W
Working temperature	450°C ± 10%

0037

SOLDERING IRON COMBINATION SET



Power 230V 50Hz 30W

0033A

HIGH PRECISION TEMPERATURE -CONTROLLED SOLDERING IRON STATION

Adjustable temperature 150-420°C, iron tip with hole ø 6 mm.



Melting point	215°
Working temperature	215 ÷ 300°C
Max temperature	420°C
Power station supply	230 V 50 Hz
Soldering power supply	24 V 48 W

0027/30W

SOLDERING IRON



Power	230 V 50 Hz 30 W
Working temperature	450°C ± 10%

0033A/TIP

SOLDERING IRON TIP SET

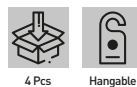

0027/40W/TIP

SOLDERING IRON TIP SET

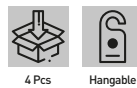

0037/TIP

SOLDERING IRON SPARE PART TIP

Set of tips with hole ø 6 mm.





0864

GAS SOLDERING IRON

Tip and solder heads with protection cap and gas igniter.



Blister

Dimensions 165 x 23 mm

0026

SOLDERING GUN

With tin and a spare pointer.



Blister

Power 230 V 50 Hz 100 W

0443

FAST HEATING SOLDERING GUN

With adjustable temperature.



Carrying case

Power 230V 50Hz 200W
Temperature 70 °C ÷ 500 °C

0024

HOT AIR GUN



Box

Temperature 300 °C - 500 °C
Air stream 280 l/min - 480 l/min
Power 230 V 50Hz 1,5 kW

0694

HOT AIR GUN SET

At 2 temperatures, with spatula, scrapers and diffusers.



10 Pcs



Carrying case

Temperature 300 °C - 600 °C
Air stream 500 l/min - 650 l/min
Power 230 V 50 Hz 1 - 2 kW

0444

DIGITAL HOT AIR GUN SET

With electronic temperature control, lcd display to show the temperature, 2 levels of air flow, ideal for heating, folding, bending, removing paint.



6 Pcs



Box



ABS

Power 230 V, 50 Hz, 2000 W
Temperature I 50°C - II 70°C ÷ 600°C - III 70°C ÷ 600°C
Air stream I 300L/min - II 300L/min - III 500L/min

0865

ELECTRIC BARBECUE LIGHTER

Lights charcoal on the barbecue or in the fireplace completely without chemicals and matchsticks. 600°C heat generated and sets charcoal on fire in approx. 30 - 60 seconds



Box

Power 230 V, 50 Hz, 2000 W
Temperature 600° C

0441

HOT KNIFE FOR POLYSTYRENE WITH ADJUSTABLE TEMPERATURE

For polystyrene, plastic, foam and sponge, adjustable cutting length, metal stand.



Box

Power 230 V, 50 Hz, 220 W
Temperature 120 - 220 - 330 - 400 - 450 °C
Cutting capacity with adjustment 20 ÷ 90 mm
Max cut 150 mm



0321

HOT KNIFE FOR POLYSTYRENE WITH ADJUSTABLE TEMPERATURE

For polystyrene, plastic, foam and sponge, adjustable cutting length.



Box

Power	230 V, 50 Hz, 130 W
Temperature	Max 450 °C
Cutting capacity with adjustment	14 ÷ 97 mm
Max cut	120 mm

0333

HOT KNIFE FOR POLYSTYRENE WITH ADJUSTABLE TEMPERATURE

For polystyrene, plastic, foam and sponge, adjustable cutting length, metal stand.



Carrying case

Power	230 V, 50 Hz, 150 W
Temperature	Max 500 °C
Max cut	150 mm

0706

GLUE GUN TRIGGER FEED



Carrying case

Power	230 V 40W 300 °C
Glue stick	Ø 12 mm

0333/150

SPARE BLADE



0034

HOT MELT GLUE STICKS



10 Pcs



Blister

Dimensions	Ø 12 x 200 mm Tot. 200 gr
------------	---------------------------

0431

GLUE GUN TRIGGER FEED

Equipped with automatic advance and Led to signal connection to electric power.



Blister

Power	230 V, 35 W, 200 °C
Glue stick	Ø 12 mm
Glue flow	16 ÷ 20 g/min



10 Pcs



Blister

Dimensions	Ø 12 x 200 mm 200 gr mm
------------	-------------------------



**0156-****FLEXIBLE OIL-CAN**

Art.	Capacity
0156/200	200 cc
0156/500	500 cc

0164/250**OILER WITH VERTICAL FLEXIBLE SPOUT****Plastic**

Capacity	250 cc
----------	--------

0171-**MEASURING JUG**

With flexible spout, screw cover and anti-dripping end cap.

**Plastic**

Art.	Capacity
0171/2	2 l
0171/3	3 l
0171/5	5 l

0172/150**PLASTIC FUNNEL**

Closing screw, flexible spout, anti-dripping top/end covers and upper handle for the hanging.

**Plastic**

Diameter	Ø150 mm
Height	435 mm

0158/500**OILER WITH FLEXIBLE SPOUT****Plastic**  *made in italy*

Capacity	500 ml
----------	--------

0473-**OIL DRAIN PAN**

With pouring spout and handles, made of high density polyethylene, impact resistant.



Art.	Capacity	Dimensions
0473/10	10 l	Ø400 x 120h mm
0473/15	15 l	Ø500 x 130h mm

0183/750**PLASTIC CAN WITH SPOUT****Plastic**  *made in italy*

Capacity	750 ml
----------	--------

0677/500
500CC HAND OPERATED LEVER GREASE GUN

Composed of metal tank and pump, coupler and 300 mm PVC flexible hose, for using with loose grease or ø 53 mm grease cartridges.



Box

Capacity	500 cc
Flexible hose sizes	ø 8 x 300 mm

0677
HAND OPERATED LEVER GREASE GUN

Composed of metal tank and pump, coupler and 450 mm PVC flexible hose for using ø 55 mm grease cartridges or loose grease (adaptor already mounted).



Box

Capacity	1000 cc
Flexible hose sizes	ø 9 x 450 mm

0677/1A
AIR OPERATED GREASE GUN

To be used with ø 55 mm cartridge or loose grease with 2 grease cartridges, 400 mm reinforced hose included and 4 jaw adjustable fitting.



Box

Capacity	800 cc
Dimensions	ø 60 x 500 mm
Working pressure	4 - 6 bar
Max. pressure	10 bar

0677/500CG
GREASE CARTRIDGE

Based on lithium soap, dropping point > 185 ° C, resistant to high loads



Box

Capacity	500cc
Dimensions	ø 53 mm

0677/CG
GREASE CARTRIDGE

Based on lithium soap, dropping point > 185 ° C, resistant to high loads



Box

Capacity	650 cc
Dimensions	ø 55 mm

0677/SO
PLASTIC SUCTION DISCHARGE GUN

Box

Plastic

Capacity	500 g
Dimensions	ø 50 x 500 mm

**G030-****EMULSIFIABLE COOLANT AND LUBRICANT FLUID**

Of high quality, mixable with water in these percentages: grinding: 2.5-3.5%, turning and milling: 3.00-4.00%, deep drilling: 4.00-7.00%, threading, tapping and light stamping: 7-15%.



Art.	Quantity
G030/01	1 l
G030/05	5 l
G030/25	25 l

**S401/00****MULTI-FUNCTION SPRAY**

A multipurpose product: it lubricates, protects, and releases. It is water-repellent and corrosion preventive. It protects parts subject to exposed water-pins, levers, and outboard motor parts. It meets the nautical market requirements and thanks to its high waterproofing / water-repellent capacities it's ideal for maintenance on any machine part.



Capacity 400 ml

**S401/01****COLD GALVANIZER**

Cold galvanizer with high molecular weight, it chemically solidifies producing a long lasting metal coating. It protects all metal surfaces from oxidation. It forms an even resistant layer which can be painted or left as a final protection. It is ideal for retouching, for finishing and repairing galvanized parts.



Capacity 400 ml

**S401/02****MULTIPURPOSE GREASE**

A compound of high quality saponified greases. Grease with a wide range of use, good chemical stability, water-repellent and adhesiveness properties. It protects against water and it is perfectly stable and resistant to salty and dirty atmospheres, acid and basic solution and atmospheric corrosion. Ideal for lubricating bearing, bushings, hubs, kingpins, guides and general use on motor vehicles, farming and industrial machinery.



Capacity 400 ml

**S401/03****SOLVENT AND RELEASING**

Penetrating synthetic fluid with a high solvent and releasing power, it facilitates the releasing process of bolts, joints, threads, hinges and all other mechanical parts from rust and oxidation. It also leaves a long lasting waterproof and water repellent protective film.



Capacity 400 ml

**S401/04****PURE SILICONE OIL**

Solution based on pure silicone oil that has anti-stick release agents and lubricants on various materials. It also gives a good water repellency on treated materials preventing the accumulation of electrostatic charges. It works as polishing and protective on plastic parts and it protects the seals from cracking increasing tightness and durability.



Capacity 400 ml



S401/05
WELDING ANTIADHESIVE

A product made of filmforming synthetic polymers which, owing to their special features, it prevents the seizure of welding spatter to any surface. The film also prevents oxidation and corrosion caused by chemicals. It is suitable for autogenous, electric and inert-gas welding. The compound is free of silicon substances.



Capacity 400 ml

S401/06
SPRAY STAINLESS STEEL

This zinc coating is silicone resin based and it forms a protective layer. Formulated to remain unchanged over time with exceptional resistance to chemical corrosion and weathering and good mechanical strength. Quick drying coating.



Capacity 400 ml

S401/08
DRY PTFE LUBRICATING AGENT

Dry, water-repellent, anti-adhesive lubricant. Does not withhold dust and does not stain. It forms a dry and flexible layer of PTFE on the part treated that adheres tightly to metal, wood, and plastic, etc. Temperature-resistant between -80°C and +260°C. It provides protection against corrosion. Ideal for drive chains, threads, rollers, belts, guides and heavy-duty tools, etc.



Capacity 400 ml

S401/09
COPPER GREASE

This product is made of super fine foliated copper particles and special corrosion inhibitors. It has protective and lubricating properties at high temperatures. Resistance to high temperatures (1000 °C), high adhesive capacity and anti-corrosion capacity make it ideal for all cases where heat or a highly corrosive environment can create irreversible blocks: slip, ring, pins, motor, exhausts, electrical, contacts, threaded connections, injection valves, etc.



Capacity 400 ml

S401/10
CUTTING OIL

New product developed for specific professional applications in hard metal cutting and operations. Oil with a paraffin mineral base enriched with special EP anti-weld additives. Ideal for use in difficult threading operations with particularly hard, alloy steel. Suitable for use in the hydraulic sector.



Capacity 400 ml

S401/11
AIR CLEAN

It removes dust even from lesser accessible parts. It is a must for cleaning lenses, objectives, computers and any kind of mechanism.



Capacity 400 ml



**S401/12****DE-OXIDIZING AGENT FOR ELECTRIC CONTACTS**

Specifically formulated for the deep cleaning of electrical, electronic and electromagnetic contacts. It immediately removes humidity and oily substances like grease, oil, sludge, wax and glue from the surface, leaving it clean and degreased. The product might be corrosive to certain delicate surfaces.



Capacity 400 ml

**S401/13****VASELINE OIL**

Pure vaseline oil particularly indicated for applications where periodically maintenance, cleaning and lubrication are necessary. It is recommended for the lubrication of delicate mechanism. Due to its special formulation it protects and lasts for long time.



Capacity 400 ml

**S401/07****BRAKE CLEANER, CARBURETORS AND THROTTLE BODIES**

Special cleaner particularly effective on all mechanical components that require to be degreased without rinsing such as brakes and clutches. It rapidly dissolves oil, grease and other dirty substances. Developed for cleaning throttle bodies and intake manifolds that are made out of plastic material. It removes carbon and oily deposits from the throttle body and the entire intake system. It reduces the emission of harmful exhaust gases.



Capacity 500 ml

**S401/14****PURE ZINC**

It is a cold galvanizer with high molecular weight. It chemically solidifies producing a long-lasting metal coating. It protects all metal surfaces from oxidation. It forms a resistant layer which can be painted or left as a final protection. It offers exceptional resistance to weathering in difficult conditions. It is ideal for retouching, finishing, and repairing galvanized parts.



Capacity 400 ml

**S401/15****ZINC ADHESIVE LUBRICANT FOR CHAINS**

High performance chain grease, this high quality product developed and tested for the racing industry (on-and off-road motorcycles) provides guaranteed lubrication for extended periods of intense use. It reduces wearing of chains, crowns, pinions and all mechanical moving parts, while also protecting against water and dust.



Capacity 400 ml

**S401/16****LITHIUM GREASE**

Contains lithium and titanium oxides that make it specific and suitable for the nautical sector. It has long-term lubrication and performs in the presence of saline and aggressive atmospheres. It has long-term stability and resistance to oxidation. It protects surfaces from corrosive agents and it is suitable for both high temperatures (220°C/428°F) and low temperatures (-40°C/-40°F). Excellent for lubricating pins, joints, transmissions, levers, suspensions, hinges and exposed machine parts.



Capacity 400 ml



0660-

PLASTIC FUEL TANK

With flexible filler, "un" certified according to european directives



Plastic

Art.	Capacity Liters	Dimensions	Net weight
0660/05	5	260 x 120 x 250h mm	0,5 kg
0660/10	10	330 x 160 x 300h mm	0,7 kg
0660/20	20	400 x 200 x 360h mm	1 kg

0189-

METAL FUEL TANK

With flexible filler, "un" certified according to european directives



Art.	Capacity Liters	Net weight
0189/05C	5	1,5 kg
0189/10C	10	2,5 kg
0189/20C	20	3,7 kg

0189/G

METAL POURING SPOUT



Pack 10

0194

METAL POURING SPOUT



Pack 5

0356

TROLLEY PRESSURE SPRAYER WITH BRASS LANCE PIPE

With FPM gaskets.



Box

Capacity 16 L

0303

PRESSURE SPRAYER WITH BRASS LANCE PIPE

With gauge and FPM gaskets.



Box

Capacity 8 L

**0274****PRESSURE SPRAYER WITH BRASS NOZZLE**

With FPM gaskets.



Capacity 2 l

0289**PRESSURE SPRAYER WITH BRASS NOZZLE**

Rubber gaskets.



Capacity 2 l

P024/06**LEVER ACTION HAND PUMP**

For transferring lubricating oil, diesel, kerosene and antifreeze drums with rigid steel pipe Ø 16 x 700 mm with thread M16 x 1 and delivery pipe in plastic.



Box

Alu

Aluminum

Capacity	6 l/min
Single stroke capacity	0.10 l
Pump thread	2" / 1-1/2"

P024/15**LEVER ACTION HAND PUMP**

For transferring lubricating oil, diesel, kerosene and antifreeze drums with rigid steel pipe Ø 20 x 820 mm with 1/2" gas thread and plastic delivery pipe.

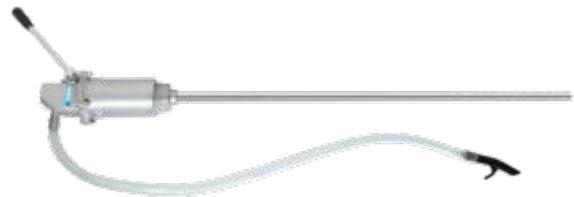

Box

Alu

Aluminum

Capacity	15 l/min
Single stroke capacity	0.35 l
Pump thread	2" / 1-1/2"

0385**ROTARY HAND PUMP**

For transferring lubricating oil, diesel, kerosene and antifreeze drums with telescopic suction pipe.



Box

Alu

Aluminum

Capacity	20 l/min
Pump thread	2"

0386**LEVER ACTION HAND OIL PUMP**

For transferring lubricating oil, diesel, kerosene and antifreeze drums with telescopic pipe.



Box

Capacity	18 l/min
Pump thread	2" / 1-1/2"

0474/PP
PVC DIESEL GUN

Box

Capacity	60÷80 l/min
Nozzle	Ø25 mm
Inlet thread	1" BSP

0474/PA
AUTOMATIC DIESEL GUN

Box

Capacity	90 l/min
Nozzle	Ø25 mm
Inlet thread	1" BSP

0272
DRILL PUMP

For no flammable, explosive, corrosive and oily liquid. Suitable use for rack spindles.



Blister

Plastic

Hydraulic head	30 m
Pump capacity	40 l/min
Max. pressure	0.3 MPa
Max speed	3400 rpm
Max temperature	40°C
Hose diameter	19 mm 3/4"

0474/PE
NOZZLE OIL GUN

With swivel connector.



Box

Alu

Aluminum

Capacity	60÷120 l/min
Nozzle	Ø25 mm
Inlet thread	1" BSP

0755
12VDC DIESEL PUMP

For mineral oil and diesel.



Box

Motor	DC 12 V, 175 W
Motor speed	4500 rpm
Pump capacity	40 l/min
Hydraulic head	2 m
Suction	4 m
Inlet thread	25 mm
Size	200 x 120 x 155 mm
Usage time	Max 30 min



R608

2000 W INFRARED HEATER WITH SUPPORT FOR WALL MOUNTING

Dust and water proof, metal housing, with metal net-cover and remote control.



Power 230 V, 2000 W

R609

INFRARED HEATER

With support for wall mounting metal housing, with metal net-cover.



Power 230 V, 1300 W

R60XA

TRIPOD ELECTRIC RADIANT INFRARED HEATER

Metal housing, with metal net-cover.



Art.	Power	Tripod height without heaters
R609A	230 V 1,3 kW	600 ÷ 1500 mm
R610A	230 V 2 kW	600 ÷ 1500 mm

R610

INFRARED HEATER

With support for wall mounting metal housing, with metal net-cover.



Power 230 V, 2000 W

R60XB

ELECTRIC RADIANT INFRARED HEATER WITH STAND

Metal housing, with metal net-cover.



Art.	Power
R609B	230 V 1,3 kW
R610B	230 V 2 kW

T609

ADJUSTABLE HEIGHT TRIPOD

Suitable for light, heater.



Height Upper fixing 600 ÷ 1500 mm M 8

B609

INFRARED BULB

230V, 1300 W.



Length 250 mm

B610

INFRARED BULB

230V, 2000 W.



Length 340 mm

0218-
LED FLOODLIGHTS

Aluminium super slim die-cast housing, tempered glass.



Art.	Power	Luminous flux	Color temperature	LED number	Cable	Dimensions
0218/10	230 V, 50 Hz, 10 W	800 lm	4000 K	15 SMD LED	30 cm, H05RN-F 3x1.0 mm ² mm	150 x 95 mm
0218/20	230 V, 50 Hz, 20 W	1600 lm	4000 K	28 SMD LED	30 cm, H05RN-F 3x1.0 mm ² mm	145 x 120 mm
0218/30	230 V, 50 Hz, 30 W	2400 lm	4000 K	42 SMD LED	30 cm, H05RN-F 3x1.0 mm ² mm	180 x 150 mm
0218/50	230 V, 50 Hz, 50 W	4000 lm	4000 K	56 SMD LED	30 cm, H05RN-F 3x1.0 mm ² mm	210 x 180 mm

0218-XB
LED FLOODLIGHT WITH STAND

Aluminium super slim die-cast housing, tempered glass.



Art.	Power	Luminous flux	Color temperature	Cable
0218/10B	230 V, 50 Hz, 10 W	800 lm	4000 K	2 m, 3x1 mm ² H05VV-F
0218/20B	230 V, 50 Hz, 20 W	1600 lm	4000 K	2 m, 3x1 mm ² H05VV-F
0218/30B	230 V, 50 Hz, 30 W	2400 lm	4000 K	2 m, 3x1 mm ² H05VV-F
0218/50B	230 V, 50 Hz, 50 W	4000 lm	4000 K	2 m, 3x1 mm ² H05VV-F

0218-XS
LED FLOODLIGHT WITH MOTION AND BRIGHTNESS SENSOR

Aluminium super slim die-cast housing, tempered glass.



Art.	Power	Luminous flux	Color temperature	Cable
0218/10S	230 V, 50 Hz, 10 W	800 lm	4000 K	30 cm, 3x1 mm ² H05VV-F
0218/20S	230 V, 50 Hz, 20 W	1600 lm	4000 K	30 cm, 3x1 mm ² H05VV-F
0218/30S	230 V, 50 Hz, 30 W	2400 lm	4000 K	30 cm, 3x1 mm ² H05VV-F
0218/50S	230 V, 50 Hz, 50 W	4000 lm	4000 K	30 cm, 3x1 mm ² H05VV-F



0218/50T

50W LED FLOODLIGHT WITH TRIPOD

Aluminium super slim die-cast housing, tempered glass.



Box

Alu

Aluminum



IP65

Power	220 - 240 V, 50 Hz, 50W
Luminous flux	4000 lm
Color temperature	4000 K
Cable	2 m, 3x1 mm ² H05VV-F

0713/15

LED FLOODLIGHT WITH MAGNETIC BASE

To fit on cars, offroads, campers, boats, agricultural machines and earthmoving machines, with 3A fuse and car plug lighter.



Box



Power	DC 9 ÷ 32 V (12 V, 24 V) 15 W
LED number	5 x 3 W
Luminous flux	1050 lm
Color temperature	6000 K
Lighting distance	5 m - 23 lux; 8,5 m - 10 lux m
Cable length	2 m
Projector size	108 x 108 mm
Base dimensions	Ø 86,50 mm
Back holes center distance	87 x 28 mm M6 mm
Overall dimensions	108 x 86,50 x 160 mm

0713/18

LED FLOODLIGHT WITH MAGNETIC BASE

To fit on cars, offroads, campers, boats, agricultural machines and earthmoving machines, with 3A fuse and car plug lighter.



Box



Power	DC 9 ÷ 32 V (12 V, 24 V) 18 W
LED number	6 x 3 W
Luminous flux	1260 lm
Color temperature	6000 K
Lighting distance	5 m - 45 lux; 12 m - 10 lux m
Cable length	2 m
Projector size	Ø 116 mm
Base dimensions	Ø 86,50 mm
Back holes center distance	87 x 28 mm M6 mm
Overall dimensions	116 x 86,50 x 165 mm

0713/27

LED FLOODLIGHT WITH MAGNETIC BASE

To fit on cars, offroads, campers, boats, agricultural machines and earthmoving machines, with 3A fuse and car plug lighter.



Box



Power	DC 9 ÷ 32 V (12 V, 24 V) 27 W
LED number	9 x 3 W
Luminous flux	1890 lm
Color temperature	6000 K
Lighting distance	5 m - 85 lux; 15,5 m - 10 lux m
Cable length	2 m
Projector size	Ø 116 mm
Base dimensions	Ø 86,50 mm
Back holes center distance	87 x 28 mm M6 mm
Overall dimensions	116 x 86,50 x 165 mm

0343

FLEXIBLE ARM LAMP



Box



IP20

Power	110 / 230 V 50 / 60 Hz
Bulb	Max 40 W, E27 not included
Range	800 mm
Clamp capacity	35 mm

0366

56 LED MAGNIFIER LAMP

With lense.



Box



IP20

Power	230 V 50 Hz 8 W
Magnification	2x
Luminous flux	600 lm
Color temperature	6500 K
Lens	Ø 120 mm
Range	810 mm
Clamp capacity	70 mm

0530
LOW CONSUMPTION LAMP WITH LENS

With lens.



Box

Power	230 V 50 Hz 22 W
Magnification	3x
Lens	Ø 120 mm
Range	810 mm
Clamp capacity	70 mm
Luminous flux	1000lm

0530A
NEW
LOW CONSUMPTION LAMP

With lens.



Box

Power	250V 50 Hz 11W
Magnification	3x
Lens	127 mm
Clamp capacity	75 mm
Luminous flux	1000 lm
Color temperature	6000 K

0891A
NEW
LOW CONSUMPTION LAMP

Led lamp with two lenses, dimmable touch buttons, 6 UV Led lights and a super bright and adjustable light point. Lifetime up to 25,000 hours.



Power	250V 50 Hz 11W
Magnification	2x + 6x
Lens	138 mm
Clamp capacity	75 mm
Luminous flux	1000 lm
Color temperature	6000 K

0516
LOW CONSUMPTION LAMP

With lens.



Box

Power	230V 50Hz 2 x 9W
Magnification	2x
Lens	190 x 157 mm
Range	810 mm
Clamp capacity	70 mm
Luminous flux	1000 lm

0344
FLEXIBLE ARM LAMP

With lens. Bulb not included.



Box

Power	230 V 50/60 Hz
Bulb	Max 60 W, E27 not included
Magnification	2x
Lens	Ø 100 mm
Range	800 mm
Clamp capacity	35 mm

0661
TABLE LAMP

With lens.



Box

Power	230 V 50 Hz 11 W
Magnification	2x
Lens	Ø 89 mm

**0625****HEAD LIGHT WITH MAGNIFYING LEN SET**

Box

Multiplier	Target distance mm
1,2x	520 ÷ 620
1,8x	230 ÷ 320
2,5x	150 ÷ 250
3,5x	80 ÷ 120
Bulb	2,2 V - 0,25 A
Battery	2x AAA

L006**LED MAGNIFIER**

Box

Lens	50 x 50 mm
Magnification	3x
LED	5 - 9000 mcd
LED	1
Battery	4x LR1130
Pack	10

0482/3**HEAD LAMP WITH SENSOR**

Switch on and off function by passing the hand in front of the lamp.



Box



LED	3 W COB
Luminous flux	Max 300 lm
Color temperature	6500 K
Battery	3.7 V 1500 mAh Li-ion
Autonomy	4h
Recharging time	3h

0493/2**LED HEADLIGHT**

120lm, with elastic belt, 2 functions: focus and flash, for using with 3 batteries AAA type.



Box

Not included batteries	3 x AAA
Intensity	120 lm
Sizes	Ø 75 x 45 x 45 mm
Autonomy	5 h

0659**CRYSTAL LENS SET**

12 Pcs



Expositor

Contents	Magnifications
3 Pcs Ø 50	3x - 10x mm
3 Pcs Ø 60	3x - 8x mm
3 Pcs Ø 75	3x - 8x mm
3 Pcs Ø 90	3x - 8x mm

0437**HIGH POWERFUL LED TORCH**

Long range, distance capacity more than 150m, long life.



Box

Not included batteries	4x C
LED power	3 W
Autonomy	25 h / 100 %

0493/1**LED HEADLIGHT**

80lm, made of ABS and rubber cover, with elastic belt, 2 functions: focus and flash, for using with 3 batteries AAA type.



Box

Not included batteries	3 x AAA
Intensity	80 lm
Sizes	Ø 50 x 42 x 58 mm
Autonomy	10 h

0209**10 + 1 LED MAGNETIC WORK LIGHT**

With rotating head, Led on the top and front with 2 brightness levels.



Blister



Aluminum



IP20

Luminous flux	50 - 300 lm
Color temperature	6500 K
Not included batteries	3x AAA
Tilting head	180°
Revolution	180°
Dimensions	35 x 330 mm

0128A
COB +1 LED POCKET TORCH LIGHT WITH MAGNET

Swivel clip, long lasting, small size and high brightness make it essential in professional and do-it-yourself lines.



Sizes	174 x 43 x 22 mm
Luminous flux	140 lm
Not included batteries	3x AAA

0787
ALUMINUM TORCH

Not included batteries	2x C
LED number	8 LED 11000 mcd
Sizes	Ø 48,5 x 31 x 215 mm

0107
30 + 7 LED MAGNETIC LIGHT

With magnet and hook on the back side



Single LED life	100000 hours
Intensity	50 lm
Not included batteries	3x AA
Dimensions	40 x 35 x 203 mm

0291
24 + 3 LED MAGNETIC LIGHT

With magnet and hook on the back side.



Single LED life	100000 hours
Not included batteries	3x AAA

0671/1P
WHITE LED FLASHLIGHT WITH EXTRA BRIGHTNESS

Not included batteries	2x AAA
LED number	1 - 9000 mcd
Sizes	Ø 12,5 x 141 mm

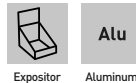
0492
LED FLASHLIGHT WITH TELESCOPIC MAGNET

Button batteries	4 x LR44
LED number	6
Intensity	6 x 10 lm
Sizes	Ø 30 x 21 x 180 mm
Max length	710 mm
Autonomy	3 h

0311
24 LED MAGNETIC LIGHT

With magnet and hook on the back side.



Single LED life	100000 hours
Not included batteries	3x AA

0338
ALUMINUM HAND TORCH WITH 1 LED AND MANUAL ZOOM

3 light types: strong, media and flashing; adapter to work with 3 batteries AAA type in a box.



Battery	1 li-ion 3.7V/ 1800 mAh
LED	Q3 3 W
Sizes	Ø 34,5 x 28 x 135 mm
Battery charger	110 / 230 V 50 / 60 Hz
Autonomy	4 h



0597

RECHARGEABLE LED LIGHT WITH MAGNET

With battery charger 12Vdc and 230Vac, foldable, hanging and magnetic.



Battery	3.7 V 1800 mAh
LED	8 SMD + 5 LED
Recharging time	8 ÷ 10 h
Autonomy	7 ÷ 8 h



0889

RECHARGEABLE LED LIGHT WITH MAGNET

With battery charger 12VDC and 230VAC, foldable, hanging and magnetic.



Battery	3,7 V - 1100 mAh - Lithium
LED	21 + 5 - 9000 mcd
Recharging time	4 ÷ 5 h
Autonomy	4 ÷ 6 h



0693A

RECHARGEABLE LED LAMP

With charging station, foldable, hanging and magnetic



Battery	3,7V - 2600mAh - Li-ion
LED	6W COB LED - 1W SMD 6500K
Luminous flux	600 lm
Recharging time	4h
Autonomy	4.5h Eco mode
Working temperature	-10°C ÷ 40°C



0401

COB LED TECHNOLOGY RECHARGEABLE LAMP

High capacity lithium battery for long time operation, magnetic back for hand-free application, flexible standing arm for multi-angle lighting purposes, strong light output 180 lumens.



Power	100 ÷ 240 V , 50 ÷ 60 Hz
Battery	3,7 V - 2600 mAh - Li-ion
Recharging time	6 h
Autonomy	3,5 h
Intensity	180 lm



0123

MULTIFUNCTION USB RECHARGEABLE LED LIGHT

With front torch with various steps of brightness, lateral white and red Leds with flashing function. Usb recharging cable and transformer. Charge and recharge status Led . It can be charged directly from a computer.



Battery	3.7V - 1800mAh - Li-ion
LED	24 Cree XPG R5
Intensity	30 - 300 lm
Dimensions	191 x 99 x 148 mm
Battery charger	USB 110 - 230 V 50 - 60 Hz
Autonomy	2.5 h



G900

CAMPING LANTERN



Dimensions	Ø 60 x 160 mm
Intensity	150 lm
Not included batteries	3 x AA



L008

SLIM INSPECTION CORDLESS LED LIGHT

Rechargeable, high capacity lithium battery for long time operation, strong light output 400 lumen, the slim design and robust structure make it indestructible even if it falls from a height of one meter or, if it is forgotten on a flat floor, the car passes over it.



Power	100 ÷ 240 V , 50 ÷ 60 Hz
Battery	3,7 V 2400 mAh Lithium
Luminous flux	400 lm
Recharging time	3,5 h
Autonomy	3 - 10 h
Intensity	400 lm



0445/20
RECHARGEABLE LED FLOODLIGHT

With switch, adapters to recharge batteries with car dc lighter and home ac 230V.



Box

Alu

Aluminum

IP65

Power	DC 12 - 24 V, 20 W; AC 230 V 20W
Luminous flux	600 - 1450 lm
Battery	7.4V 5400mAh Li-ion
Autonomy	1,5 h

0342
PORTABLE NEON LAMP WITH HOOK



Blister

IP20

Power	230 V 50 Hz 8 W
Dimensions	ø 31 x 435 mm
Cable	5 m

0900/BL
MAGNETIC LED LAMP WITH EXTENDABLE UNDERCABINET STAND

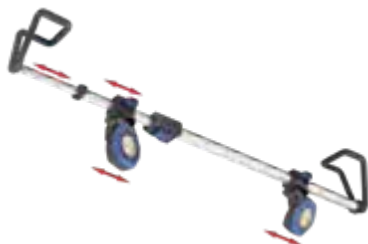
The under-hood lamp consists of two magnetic, 360-degree rotatable Cob Led light points for a maximum of 2800 lumens (1400lm + 1400lm) and an extendable bar up to 2100 mm to fit any type of hood.



Box

ABS
Alu

Aluminum

LED	COB
Power	USB Type C 5 V 2 A
Battery	3.7 V 5200 mAh Li-ion
Luminous flux	2 x 400-1400 lm
Recharging time	4 h
Autonomy	4 h
Adjustable extension clamps	850 ÷ 2100 mm

0429
WORKING LAMP HOLDER WITH 5M POWER CORD

Without on/off switch, max 60 W for incandescent lamps, E27 screw cup bulb, voltage range 12 ÷ 230V; bulb not included.



Hangable

Cable length	5 m
Screw cup bulb	E27
Voltage	230 V

0900
MULTI PORTABLE MAGNETIC LED LIGHT

COB Led portable lamp made in impact-resistant ABS. The ledlamp is adjustable in four different light intensities from 350 to 1400 Lumen. The strong magnet at the base and the rotatable body through 180°, makes it perfect to be used in any circumstance.

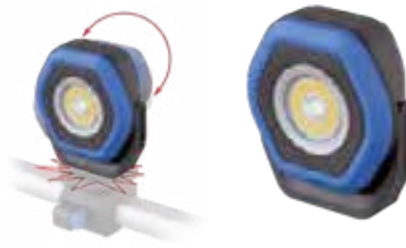

Box

Alu

Aluminum

LED	COB
Power	USB Type C 5 V 2 A
Battery	3.7 V 5200 mAh Li-ion
Luminous flux	350 ÷ 1400 lm
Recharging time	4 h
Autonomy	3 h ÷ 14 h
Dimensions	116 x 101 x 41.5 mm

0840
RECHARGEABLE LED LAMP WITH ADJUSTABLE HOOKS AND MAGNETS

Made of ABS and polycarbonate, with lithium battery, 12V car plug adapter and 230V home adapter, charging indicator light.



Box

ABS

Power	DC 12 V 7,2 W; AC 230V
Working lamp dimensions	ø 38 x 1080 mm
Adjustable extension clamps	1210 ÷ 1950 mm
Battery	7.4 V, 1800 mAh Lithium
Intensity	900 lm, 36 SMD
Recharging time	4 - 5 h
Autonomy	3h



**0621/A3****AUTO RE-ENTERING CABLE REEL**

Overload protection, Led light on the cable reel to show the presence of power.



Box

Cable length	10 m
Cable type	3 x 1,50 mm ² H05RR-F
Power	12 V ÷ 240 V
Max power for rolled cable	1200 W
Max power for unrolled cable	1800 W

A010-X**CABLE REEL**

Double isolation cable H05VV-F homologated, homologated PVC pressure-cast plug, thermal circuit breaker with manual reset, max. Power with rolled cable 1,2kw, max. Power with unrolled cable 3,4kw.



Box

Art.	Cable length	Stem	Drum
A010/10	10 m	3 x 1,5 mm ²	ø 200 mm
A010/20	20 m	3 x 1,5 mm ²	ø 250 mm

A010/30T**CABLE REEL**

Complies with standard EN 61316, flexible cord H07RN-F, neoprene homologated, IP 44 plugs, thermal circuit breaker, with manual reset, max. Power with rolled cord 5kw, max. Power with unrolled cord 11 kw.



Box

Power	380 V
Cable length	30 m
Stem	4 x 2,5 mm ²
Drum	ø 340 mm

0428**AUTOMATIC CABLE REEL WITH LAMP HOLDER**

Overload protection, max 60 W for incandescent lamps, Led light on the cable reel to show the presence of power, bulb not included.



Box



Cable size	13 + 1 m - H05RR-F - 2 x 1mm ²
Screw cup bulb	E27
Voltage	12 ÷ 230 V

A010-**CABLE REEL**

Complies with standard EN 61242, double isolation cable H05VV-F homologated, homologated PVC pressure-cast plug, thermal circuit breaker with manual reset, max. Power with rolled cable 1,2kw, max. Power with unrolled cable 3,4kw.



Box

Art.	Cable length	Stem	Drum
A010/15	15 m	3 x 1,5 mm ²	ø 190 mm
A010/25	25 m	3 x 1,5 mm ²	ø 240 mm
A010/50	50 m	3 x 1,5 mm ²	ø 310 mm

A010/30**CABLE REEL**

Conform to standard EN 61316, flexible cord H07RN-F neoprene homologated, IP 44 plugs, thermal circuit breaker with manual reset, max. power with rolled cord 5kw max. power with unrolled cord 11kw.



Box

Power	230 V
Cable length	30 m
Stem	3 x 2,5 mm ²
Drum	ø 340 mm