



**FERVI**

# IL CATALOGO





PER I PROFESSIONISTI  
DELLA MANUTENZIONE  
E RIPARAZIONE

# 46





**CALIBRI, TRUSCHINI  
E RIGHE**

- p. 554  Calibri digitali
- p. 555  Calibri con comparatore
- p. 555  Calibri vernier
- p. 559  Truschini
- p. 559  Righe digitali

**COMPARATORI**

- p. 560  Comparatori digitali e analogici
- p. 562  Misuratori di spessore
- p. 563  Centratori

**MICROMETRI**

- p. 564  Micrometri per esterni
- p. 565  Micrometri per interni

**BLOCCHETTI, ANELLI  
E TAMPONI**

- p. 566  Blocchetti di riscontro
- p. 567  Anelli e tamponi

**ACCESSORI PER  
LA MISURAZIONE**

- p. 569  Basi magnetiche e supporti
- p. 572  Piani di riscontro
- p. 572  Squadre
- p. 574  Spessimetri e contafiletti

**FLESSOMETRI, LIVELLE E  
GONIOMETRI**

- p. 577  Flessometri
- p. 578  Livelle
- p. 580  Goniometri

**MISURATORI  
ANALOGICI E DIGITALI**

- p. 581  Endoscopi e Microscopi
- p. 582  Pinze amperometriche e multimetri
- p. 583  Misuratori digitali
- p. 587  Rifrattometri
- p. 588  Durometri

**BILANCE E  
DINAMOMETRI**

- p. 590  Bilance
- p. 591  Dinamometri

**C031/150**
**€ 193,00**
**CALIBRO ELETTRONICO DIGITALE INOX**

A 2 funzioni con schermo grande.



Utile	0÷150 mm   0÷6"
Lettura	0,01 mm   0,0005"
Becchi	40 mm
Asta	16 x 3 mm
Batteria	1 x LR44

**C035-**
**CALIBRO ELETTRONICO DIGITALE INOX**

Con scala di misurazione in vetro per una migliore precisione, carcassa e pulsanti in metallo, uscita dati con porta mini USB, rotella di posizionamento rimovibile, becchi di misurazione rettificati e lappati, con vite di bloccaggio.



Art.	€	Utile	Lettura	Precisione	Ripetibilità	Asta	Becchi	Becchi da interni	Batteria	Altezza cifre
C035/150	€ 75,90	0÷150 mm   0÷6"	0,01 mm   0,0005"	0,02 mm	0,01 mm	16 x 3 mm	40 mm	16,5 mm	1 x 3V CR2032	9 mm
C035/200	€ 104,00	0÷200 mm   0÷8"	0,01 mm   0,0005"	0,03 mm	0,01 mm	16 x 3 mm	50 mm	19,5 mm	1 x 3V CR2032	9 mm
C035/300	€ 182,00	0÷300 mm   0÷12"	0,01 mm   0,0005"	0,03 mm	0,01 mm	16 x 3 mm	60 mm	20,5 mm	1 x 3V CR2032	9 mm

**C033-**
**CALIBRO ELETTRONICO DIGITALE INOX**

A 3 funzioni con schermo grande.



Art.	€	Utile	Lettura	Asta	Becchi	Batteria
C033/150	€ 66,90	0÷150 mm   0÷6"	0,01 mm   0,0005"	16 x 3,2 mm	40 mm	1 x LR44
C033/200	€ 97,40	0÷200 mm   0÷8"	0,01 mm   0,0005"	16 x 3,2 mm	50 mm	1 x LR44
C033/300	€ 145,00	0÷300 mm   0÷12"	0,01 mm   0,0005"	16 x 3,2 mm	60 mm	1 x LR44

**C041/150**
**€ 37,50**
**CALIBRO ELETTRONICO DIGITALE MONOBLOCCO INOX**

A 3 funzioni con schermo grande.



Utile	0÷150 mm   0÷6"
Lettura	0,01 mm   0,0005"
Becchi	40 mm
Asta	16 x 3 mm
Batteria	1 x LR44



**C043-****CALIBRO ELETTRONICO DIGITALE INOX**

A 4 funzioni con schermo grande, regolazione micrometrica.



Art.	€	Utile	Lettura	Becchi	Asta	Batteria
C043/500	€ 357,00	0÷500 mm   0÷20"	0,01 mm   0,0005"	100 mm	25 x 6 mm	1 x LR44
C043/1000	€ 713,00	0÷1000 mm   0÷40"	0,01 mm   0,0005"	150 mm	30 x 8 mm	1 x LR44

**C005/150****€ 58,90****CALIBRO CON COMPARATORE INOX**

Utile	0 ÷ 150 mm
Lettura	0,01 mm
Becchi	40 mm
Asta	15,5 x 3 mm

**C006-****CALIBRO CON COMPARATORE INOX**

Art.	€	Utile	Lettura	Becchi	Asta
C006/150	€ 52,80	0 ÷ 150 mm	0,02 mm	40 mm	16 x 3 mm
C006/200	€ 80,40	0 ÷ 200 mm	0,02 mm	50 mm	16 x 3 mm
C006/300	€ 131,00	0 ÷ 300 mm	0,02 mm	60 mm	20 x 4 mm

**C018-****CALIBRO MONOBLOCCO INOX CROMATO OPACO**

Art.	€	Utile	Lettura	Becchi	Asta
C018/150	€ 39,70	0÷150 mm   0÷6"	1/20 0,05 mm   1/128"	40 mm	16 x 3 mm
C018/200	€ 61,80	0÷200 mm   0÷8"	1/50 0,02 mm   1/1000"	50 mm	16 x 3 mm

**C057/150**
**€ 22,80**
**CALIBRO SATINATO**

Scatola 862

Utile	0÷150 mm   0÷6"
Lettura	1/20 0,05 mm   1/128"
Becchi	40 mm
Asta	16 x 3 mm

**C011-**
**CALIBRO MONOBLOCCO INOX CROMATO OPACO**

Alta precisione, con rotellina per bloccaggio cursore, campo di misurazione 0 – 200 mm.



Scatola 862

Art.	€	Utile	Lettura	Becchi	Asta
C011/150	€ 43,30	0÷150 mm   0÷6"	1/50 0,02 mm   1/1000"	40 mm	16 x 3 mm
C011/200	€ 71,80	0÷200 mm   0÷8"	1/50 0,02 mm   1/1000"	50 mm	16 x 3 mm

**C019/150**
**€ 18,10**
**CALIBRO SATINATO**

Scatola 862

Utile	0÷150 mm   0÷6"
Lettura	1/20 0,05 mm   1/128"
Becchi	40 mm
Asta	16 x 3 mm

**C056/200**
**€ 31,70**
**CALIBRO SATINATO**

Scatola 862

Utile	0÷200 mm   0÷8"
Lettura	1/50 0,02 mm   1/1000"
Becchi	50 mm
Asta	16,5 x 3,5 mm



**C049/300**
**€ 66,90**
**CALIBRO SATINATO**

Registrazione micrometrica.



Scatola 862

Utile	0 ÷ 300 mm
Lettura	1/50 - 0,02 mm
Becchi	60 mm
Asta	20 x 4 mm

**C021-**
**CALIBRO MONOBLOCCO SATINATO INOX**

Registrazione micrometrica.



Scatola 862

Art.	€	Utile	Lettura	Becchi	Asta
C021/300	€ 188,00	0÷300 mm   0÷12"	1/50 0,02 mm   1/1000"	100 mm	23 x 6 mm
C021/500	€ 258,00	0÷500 mm   0÷20"	1/50 0,02 mm   1/1000"	150 mm	23 x 6 mm
C021/1000	€ 576,00	0÷1000 mm   0÷40"	1/50 0,02 mm   1/1000"	150 mm	32 x 8 mm

**C020-**
**CALIBRO SATINATO**

Registrazione micrometrica.



Scatola 862

Art.	€	Utile	Lettura	Becchi	Asta
C020/500	€ 162,00	0 ÷ 500 mm	1/50 0,02 mm	100 mm	23 x 6 mm
C020/1000	€ 401,00	0 ÷ 1000 mm	1/50 0,02 mm	150 mm	30 x 8 mm
C020/1500	€ 1120,00	0 ÷ 1500 mm	1/50 0,02 mm	225 mm	49 x 14 mm
C020/2000	€ 1810,00	0 ÷ 2000 mm	1/50 0,02 mm	250 mm	50 x 15 mm

**C044-**
**CALIBRO ELETTRONICO DIGITALE INOX DI PROFONDITÀ**

A 3 funzioni con schermo grande.



Scatola 862

Art.	€	Utile	Lettura	Base	Asta	Peso batteria (Kg)	Batteria
C044/200	€ 94,50	0÷200 mm   0÷8"	0,01 mm   0,0005"	100 mm	13 x 3,5 mm	0,002	1 x LR44
C044/300	€ 162,00	0÷300 mm   0÷12"	0,01 mm   0,0005"	150 mm	15 x 4 mm	0,002	1 x LR44



**C007-**

**CALIBRO DI PROFONDITÀ SATINATO**



Art.	€	Utile	Letture	Base	Asta
C007/200	€ 40,90	0 ÷ 200 mm	1/50 0,02 mm	100 mm	9,6 x 4,5 mm
C007/300	€ 56,20	0 ÷ 300 mm	1/50 0,02 mm	100 mm	12 x 4 mm

**C010/200**

€ 59,10

**CALIBRO PER TRACCIATURA MONOBLOCCO SATINATO**

**C010/200P € 8,70**

**SET 2 PUNTE PER CALIBRO C010/200**



Utile	0÷200 mm   0÷8"
Letture	1/10 0,1 mm   1/64"
Becchi	10 mm
Asta	16 x 3 mm



**CF08**

€ 9,20

**CALIBRO PER MISURA INTERASSE FORI DADI RUOTA**

Utile per la misurazione della distanza dei fori di fissaggio del cerchio.  
Per cerchi con 4, 5, 6 e 8 fori.



Utile	4-8 LUG 100 ÷ 210 mm
-------	----------------------





**T092-**
**TRUSCHINO DIGITALE MULTIFUNZIONE**

A 4 funzioni con schermo grande, con punta a tracciare.



Scatola

Art.	€	Campo di misura	Letture	Precisione	Peso netto	Batteria
T092/300	€ 595,00	0÷300 mm   0÷12"	0,01 mm   0,0005"	0,03 mm   0,015"	4 kg	1x 3V CR2032
T092/600	€ 989,00	0÷600 mm   0÷24"	0,01 mm   0,0005"	0,05 mm   0,025"	9 kg	1x 3V CR2032

**T100-**
**TRUSCHINO IN ACCIAIO CROMATO OPACO**

Con punta a tracciare.



Scatola

Art.	€	Campo di misura	Letture	Peso netto
T100/300	€ 121,00	0 ÷ 300 mm	0,02 mm	2 kg
T100/500	€ 239,00	0 ÷ 500 mm	0,02 mm	5,5 kg

**Rx**
**RIGA CON DISPLAY DIGITALE MULTIFUNZIONE**

La riga può essere tagliata per utilizzare la lunghezza desiderata. Funzioni: on/off - mm/inch - zero - abs/inc - autospegnimento.



Scatola

Art.	€	Lunghezza totale	Utile	Letture	Batteria
R060	€ 90,00	630 mm - 24.8" inch	500 mm - 19.7"	0,01 mm   0.001"	2 x 3 V CR2032
R100	€ 117,00	1000 mm - 40" inch	900 mm - 35"	0,01 mm   0.001"	2 x 3 V CR2032

**C064 € 115,00**
**COMPARATORE DIGITALE CENTESIMALE MULTIFUNZIONE**

Funzioni principali: azzeramento in ogni posizione, conversione mm/inch memoria e ricerca del valore min/max, spegnimento automatico.



Scatola 878

Campo di misura	0÷12,7 mm   0÷0,5"
Risoluzione	0,01 mm   0,0005"
Precisione	0,02 mm   0,002"
Diametro quadrante	60 mm
Batteria	1x SR44W

**C004 € 94,90**
**COMPARATORE MILLESIMALE**

Scatola 878

Diametro quadrante	60 mm
Campo di misura	0 ÷ 1 mm
Letture	0,001 mm
Precisione	0,002 mm

**C002 € 57,10**
**COMPARATORE CENTESIMALE**

Scatola 878

Diametro quadrante	60 mm
Campo di misura	10 mm
Letture	0,01 mm
Precisione	0,015 mm

**C023G € 22,10**
**COMPARATORE CENTESIMALE**

Scatola 878

Diametro quadrante	60 mm
Campo di misura	10 mm
Letture	0,01 mm
Precisione	0,015 mm

**C060 € 241,00**
**COMPARATORE DIGITALE MILLESIMALE MULTIFUNZIONE**

Funzioni principali: azzeramento in ogni posizione, conversione mm/inch, memoria e ricerca del valore min-max, spegnimento automatico.



Scatola 878

Utile	0÷2,40 mm   0÷0,094"
Letture	0,01 mm   0,0005"
Dimensioni piatto	Ø 24 mm
Altezza cifre	8 mm
Batteria	1 x 3V CR2032
Dimensioni	Ø 50 x 51 mm

**C017 € 65,70**
**COMPARATORE CENTESIMALE ANTIURTO**

Con movimento su rubini e resistente agli spruzzi d'acqua, con nasello.



Scatola 878

Diametro quadrante	55 mm
Campo di misura	10 mm
Letture	0,01 mm
Precisione	0,015 mm

**C023 € 33,50**
**COMPARATORE CENTESIMALE**

Scatola 878

Diametro quadrante	60 mm
Campo di misura	10 mm
Letture	0,01 mm
Precisione	0,015 mm

**C023/N € 37,90**
**COMPARATORE CENTESIMALE**

Scatola 878

Diametro quadrante	60 mm
Campo di misura	10 mm
Letture	0,01 mm
Precisione	0,015 mm





**C002/42**

€ 41,20

**COMPARATORE CENTESIMALE**



Scatola 878

Diametro quadrante	42 mm
Campo di misura	5 mm
Letture	0,01 mm
Precisione	0,015 mm

**T003-**

**INDICATORE A TASTO CENTESIMALE**



Scatola 2270

Art.	€	Diametro quadrante	Campo di misura	Letture	Precisione	Punta tastatrice
T003	€ 101,00	32 mm	0,8 mm	0,01 mm	0,015 mm	Ø 2 mm
T003G	€ 60,10	32 mm	0,8 mm	0,01 mm	0,008 mm	Ø 2 mm

**C048**

€ 80,50

**COMPARATORE CENTESIMALE**

Con nasello.



Scatola 878

Diametro quadrante	60 mm
Campo di misura	30 mm
Letture	0,01 mm
Precisione	0,015 mm

**T007-**

**INDICATORE A TASTO CENTESIMALE**



Scatola

Art.	€	Diametro quadrante	Campo di misura	Letture	Precisione	Punta tastatrice
T007	€ 102,00	40 mm	0,8 mm	0,01 mm	0,011 mm	Ø 2 mm
T007G	€ 65,20	40 mm	0,8 mm	0,01 mm	0,008 mm	Ø 2 mm

**T006**

€ 109,00

**INDICATORE A TASTO CENTESIMALE CON TASTATORE LUNGO**



Scatola 2270

Diametro quadrante	40 mm
Campo di misura	0,8 mm
Letture	0,01 mm
Precisione	0,011 mm
Punta tastatrice	Ø 2 mm
Lunghezza punta tastatrice	29 mm

**T005**

€ 121,00

**INDICATORE A TASTO BIMILLESIMALE**



Scatola 2270

Diametro quadrante	32 mm
Campo di misura	0,2 mm
Letture	0,002 mm
Precisione	0,005 mm
Punta tastatrice	Ø 2 mm

**T011**

€ 92,60

**INDICATORE A TASTO CENTESIMALE**



Scatola 2270

Diametro quadrante	32 mm
Campo di misura	0,8 mm
Letture	0,01 mm
Precisione	0,011 mm
Punta tastatrice	Ø 2 mm

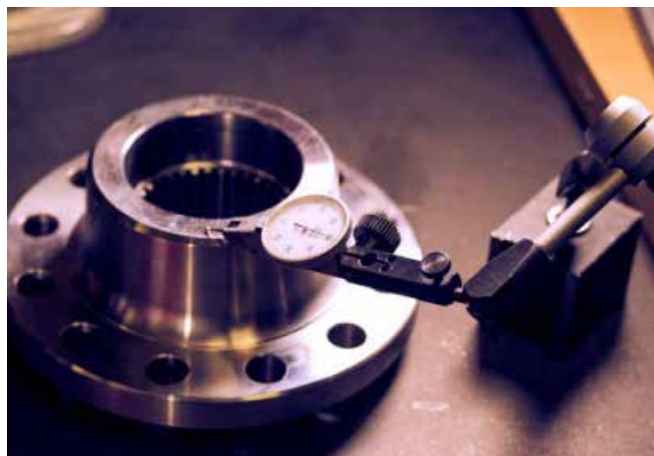

**A016-**

**ALESAMETRO CON COMPARATORE**



Scatola

Art.	€	Campo di misura	Letture	Profondità foro
A016/6/10	€ 156,00	6 ÷ 10 mm	0,01 mm	40 mm
A016/10/18	€ 161,00	10 ÷ 18 mm	0,01 mm	100 mm
A016/18/35	€ 161,00	18 ÷ 35 mm	0,01 mm	125 mm
A016/35/50	€ 161,00	35 ÷ 50 mm	0,01 mm	150 mm
A016/50/160	€ 161,00	50 ÷ 160 mm	0,01 mm	150 mm
A016/160/250	€ 180,00	160 ÷ 250 mm	0,01 mm	400 mm
A016/250/450	€ 204,00	250 ÷ 450 mm	0,01 mm	400 mm

**M055/120**

€ 105,00

**MISURATORE DI SPESSORI**



Scatola

Campo di misura	0 ÷ 10 mm
Letture	0,01 mm
Profondità di misurazione	120 mm

**C016**

€ 172,00

**MISURATORE DI PROFONDITÀ**



Scatola

Campo di misura	0 ÷ 110 mm
Corsa comparatore	0 ÷ 10 mm
Dimensioni base	63 x 17 mm
Letture	0,01 mm
Prolunghe	10 pz

**M062**

€ 26,10

**MISURATORE DI SPESSORI DIGITALE**



Scatola

Campo di misura	0 ÷ 12 mm - 0 ÷ 0,5"
Letture	0,01 mm   0,0005"
Profondità di misurazione	20 mm
Precisione	±0,1 mm   0,004"
Batteria	1 x LR44

**M055**

€ 69,10

**MISURATORE DI SPESSORI**



Scatola

Campo di misura	0 ÷ 10 mm
Letture	0,01 mm
Profondità di misurazione	9 ÷ 16 mm

**C014-**

**MISURATORE RAPIDO PER INTERNI**



Scatola

Art.	€	Campo di misura	Bracci	Tastatori	Letture
C014/15/35	€ 156,00	15 ÷ 35 mm	50 mm	Ø 3 x 3 mm	0,01 mm
C014/35/55	€ 156,00	35 ÷ 55 mm	80 mm	Ø 3 x 6 mm	0,01 mm
C014/55/75	€ 156,00	55 ÷ 75 mm	80 mm	Ø 3 x 6 mm	0,01 mm
C014/75/95	€ 156,00	75 ÷ 95 mm	100 mm	Ø 3 x 8 mm	0,01 mm

**A020**

€ 147,00

**AZZERZATORE CON COMPARATORE CON BASE MAGNETICA**



Scatola

Altezza di azzeramento	50 mm
Letture	0,01 mm
Utile	0 ÷ 8 mm

**A021**

€ 136,00

**AZZERZATORE CON COMPARATORE CON BASE MAGNETICA**

Per posizionare o azzerare l'altezza degli utensili, come frese a candela, direttamente sulle macchine utensili, determinando anche la posizione del mandrino della macchina.



Scatola

Utile	0±2,40 mm   0±0,094"
Letture	0,01 mm   0,0005"
Dimensioni piatto	Ø 24 mm
Altezza cifre	8 mm
Batteria	1 x 3V CR2032
Dimensioni	Ø 50 x 51 mm

**C061**

€ 249,00

**CENTRATORE A 2 ASSI**

Con asta di posizionamento.



Scatola

Comparatore	Ø 40 mm
Corsa	4,9 mm
Letture	0,01 mm
Velocità max di utilizzo	800 rpm
Attacco cilindrico	Ø 10 mm
Tastatori dritti	3
Tastatori curvi	3
Lunghezza tastatori	50 - 100 - 150 mm
Punta tastatrice	Ø 3 mm
Tracciatore snodato	50 mm

**C062**

€ 41,20

**CENTRATORE MECCANICO A MOLLA**

Scatola

Gambo	Ø 10 mm
Tastatori	Ø 4 - 10 mm

**C063**

€ 78,90

**CENTRATORE LUMINOSO**

Scatola

Gambo	Ø 20 mm
Tastatore	Ø 10 mm
Lunghezza totale	100 mm
Alimentazione	2 x SR44W

**C063/L**

€ 96,50

**CENTRATORE LUMINOSO E SONORO**

Con segnale sonoro.



Scatola

Gambo	Ø 20 mm
Tastatore	Ø 10 mm
Lunghezza totale	160 mm
Alimentazione	2 x LR1 1.5 V

**M021-**
**MICROMETRO DIGITALE ELETTRONICO**

Con frizione sul tamburo, contatti in metallo duro, funzioni: abs/inc, set, on/off e mm/inch.



Art.	€	Misura	Letture	Precisione
M021/00/25	€ 101,00	0 ÷ 25 mm - 0 ÷ 1"	0,001 mm - 0,00005"	0,003 mm - 0,00015"
M021/25/50	€ 126,00	25 ÷ 50 mm - 1" ÷ 2"	0,001 mm - 0,00005"	0,003 mm - 0,00015"
M021/50/75	€ 153,00	50 ÷ 75 mm - 2" ÷ 3"	0,001 mm - 0,00005"	0,004 mm - 0,0002"
M021/75/100	€ 178,00	75 ÷ 100 mm - 3" ÷ 4"	0,001 mm - 0,00005"	0,004 mm - 0,0002"

**M026-**
**MICROMETRO DIGITALE ELETTRONICO**

Con frizione sul tamburo con contatti in metallo duro.



Art.	€	Misura	Letture	Precisione
M026/0/25	€ 196,00	0 ÷ 25 mm - 0 ÷ 1"	0,001 mm   0,0001"	0,0002 mm   0,00008"
M026/25/50	€ 246,00	25 ÷ 50 mm - 1" ÷ 2"	0,001 mm   0,0001"	0,0002 mm   0,00008"
M026/50/75	€ 264,00	50 ÷ 75 mm - 2" ÷ 3"	0,001 mm   0,0001"	0,0003 mm   0,00012"
M026/75/100	€ 293,00	75 ÷ 100 mm - 3" ÷ 4"	0,001 mm   0,0001"	0,0003 mm   0,00012"

**M022-**
**MICROMETRO CENTESIMALE PER ESTERNI**

Con tamburo grande a 100 divisioni con contatti in metallo duro e frizione sul tamburo.



Art.	€	Misura	Letture	Precisione
M022/00/25	€ 74,40	0 ÷ 25 mm	0,01 mm	0,004 mm
M022/25/50	€ 92,50	25 ÷ 50 mm	0,01 mm	0,004 mm
M022/50/75	€ 109,00	50 ÷ 75 mm	0,01 mm	0,005 mm
M022/75/100	€ 125,00	75 ÷ 100 mm	0,01 mm	0,005 mm

**M033**
**€ 216,00**
**ASSORTIMENTO MICROMETRI CENTESIMALI PER ESTERNI**

Con contatti in metallo duro e arco verniciato.



Misura	0÷25 - 25÷50 - 50÷75 - 75÷100 - 100÷125 - 125÷150 mm
Letture	0,01 mm
Precisione	0,004 - 0,004 - 0,005 - 0,005 - 0,006 - 0,006 mm
Stelo	Ø 6,3 mm

**M033-**
**MICROMETRO CENTESIMALE PER ESTERNI**

Con contatti in metallo duro e arco verniciato.



Art.	€	Misura	Letture	Stelo
M033/00/25	€ 27,20	0÷25 mm	0,01 mm	Ø 6,3 mm
M033/25/50	€ 38,20	25÷50 mm	0,01 mm	Ø 6,3 mm
M033/50/75	€ 42,70	50÷75 mm	0,01 mm	Ø 6,3 mm
M033/75/100	€ 47,30	75÷100 mm	0,01 mm	Ø 6,3 mm

**M033-x**
**MICROMETRO CENTESIMALE PER ESTERNI**

Con contatti in metallo duro e arco verniciato.



Art.	€	Misura	Letture	Stelo
M033/100/125	€ 50,60	100÷125 mm	0,01 mm	Ø 6,3 mm
M033/125/150	€ 54,00	125÷150 mm	0,01 mm	Ø 6,3 mm
M033/150/175	€ 64,50	150÷175 mm	0,01 mm	Ø 6,3 mm
M033/175/200	€ 73,50	175÷200 mm	0,01 mm	Ø 6,3 mm
M033/200/225	€ 85,30	200÷225 mm	0,01 mm	Ø 6,3 mm
M033/225/250	€ 104,00	225÷250 mm	0,01 mm	Ø 6,3 mm
M033/250/275	€ 107,00	250÷275 mm	0,01 mm	Ø 6,3 mm
M033/275/300	€ 121,00	275÷300 mm	0,01 mm	Ø 6,3 mm



**M009-**

**MICROMETRO CENTESIMALE PER ESTERNI**

Con contatti in metallo duro, arco verniciato.



HM



863

Art.	€	Misura	Letture	Stelo
M009/300/400	€ 371,00	300 ÷ 400 mm	0,01 mm	ø 6,5 mm
M009/400/500	€ 405,00	400 ÷ 500 mm	0,01 mm	ø 6,5 mm
M009/500/600	€ 467,00	500 ÷ 600 mm	0,01 mm	ø 6,5 mm
M009/600/700	€ 556,00	600 ÷ 700 mm	0,01 mm	ø 6,5 mm
M009/700/800	€ 667,00	700 ÷ 800 mm	0,01 mm	ø 6,5 mm
M009/800/900	€ 770,00	800 ÷ 900 mm	0,01 mm	ø 6,5 mm
M009/900/1000	€ 915,00	900 ÷ 1000 mm	0,01 mm	ø 6,5 mm
M009/1000/1200	€ 1350,00	1000 ÷ 1200 mm	0,01 mm	ø 6,5 mm

**M019-**

**MICROMETRO A TRE PUNTE PER INTERNI, PER FORI CIECHI**



Scatola

Art.	€	Anello	Misura	Letture	Precisione
M019/06/08	€ 414,00	1	6 ÷ 8 mm	0,001 mm	0,004 mm
M019/08/10	€ 414,00	1	8 ÷ 10 mm	0,001 mm	0,004 mm
M019/10/12	€ 414,00	1	10 ÷ 12 mm	0,001 mm	0,004 mm
M019/12/16	€ 387,00	1	12 ÷ 16 mm	0,005 mm	0,004 mm
M019/16/20	€ 387,00	1	16 ÷ 20 mm	0,005 mm	0,004 mm
M019/20/25	€ 416,00	1	20 ÷ 25 mm	0,005 mm	0,004 mm
M019/25/30	€ 416,00	1	25 ÷ 30 mm	0,005 mm	0,004 mm
M019/30/40	€ 458,00	1	30 ÷ 40 mm	0,005 mm	0,004 mm
M019/40/50	€ 545,00	1	40 ÷ 50 mm	0,005 mm	0,005 mm
M019/50/63	€ 556,00	1	50 ÷ 63 mm	0,005 mm	0,005 mm
M019/62/75	€ 616,00	1	62 ÷ 75 mm	0,005 mm	0,005 mm
M019/75/88	€ 623,00	1	75 ÷ 88 mm	0,005 mm	0,005 mm
M019/87/100	€ 623,00	1	87 ÷ 100 mm	0,005 mm	0,005 mm
M019/100/125	€ 693,00	0	100 ÷ 125 mm	0,005 mm	0,005 mm
M019/125/150	€ 766,00	0	125 ÷ 150 mm	0,005 mm	0,005 mm

**M010-**

**MICROMETRO A PIATTELLO**

Arco verniciato.



863

Art.	€	Misura	Letture	Piattelli
M010/0/25	€ 116,00	0 ÷ 25 mm	0,01 mm	Ø 20 mm
M010/25/50	€ 143,00	25 ÷ 50 mm	0,01 mm	Ø 20 mm
M010/50/75	€ 150,00	50 ÷ 75 mm	0,01 mm	Ø 20 mm
M010/75/100	€ 158,00	75 ÷ 100 mm	0,01 mm	Ø 20 mm
M010/100/125	€ 202,00	100 ÷ 125 mm	0,01 mm	Ø 27 mm
M010/125/150	€ 229,00	125 ÷ 150 mm	0,01 mm	Ø 27 mm
M010/150/175	€ 255,00	150 ÷ 175 mm	0,01 mm	Ø 27 mm
M010/175/200	€ 269,00	175 ÷ 200 mm	0,01 mm	Ø 27 mm

**M019-x**

**ASSORTIMENTO MICROMETRI A TRE PUNTE PER INTERNI, PER FORI CIECHI**



Valigetta

Art.	€	Micrometri	Anelli	Misura	Letture	Precisione
M019/06/12	€ 1080,00	3	3	6 ÷ 12 mm	0,001 mm	0,004 mm
M019/12/20	€ 587,00	2	1	12 ÷ 20 mm	0,005 mm	0,004 mm
M019/20/40	€ 1140,00	3	2	20 ÷ 40 mm	0,005 mm	0,004 mm
M019/40/100	€ 2510,00	5	3	40 ÷ 100 mm	0,005 mm	0,005 mm

**M013/0/100**

€ 132,00

**MICROMETRO CENTESIMALE DI PROFONDITÀ**



Valigetta

Campo di misura	0÷25 mm, 25÷50 mm, 50÷75 mm, 75÷100 mm
Letture	0,01 mm
Base	100 x 17 mm

**B0x**
**SERIE BLOCCETTI DI RISCONTRO PIANO PARALLELI IN ACCIAIO LAPPATO**

Certificato di collaudo emesso dalla fabbrica, certificato Accredia a richiesta.



Valigetta



3650

Art.	€	Grado	Pezzi	Misura nominale (mm)	Progressione (mm)	Pz per passo
B008/1	€ 1130,00	1	8	25 - 50 - 75 - 100 - 250 - 300 - 400 - 500	-	1
B011/0	€ 233,00	0	11	2,5 - 5,1 - 7,7 - 10,3 - 12,9 - 15 - 17,6 - 20,2 - 22,8 - 23,4 - 25	-	1
B032/0	€ 471,00	0	32	1,005	-	1
				1,01±1,09	-	9
				1,1±1,9	0,01	9
				1±9	0,1	9
				10 - 20 - 30 - 50	1	4
B032/1	€ 292,00	1	32	1,005	-	1
				1,01±1,09	-	9
				1,1±1,9	0,01	9
				1±9	0,1	9
				10 - 20 - 30 - 50	1	4
B032/2	€ 163,00	2	32	1,005	-	1
				1,01±1,09	-	9
				1,1±1,9	0,01	9
				1±9	0,1	9
				10 - 20 - 30 - 50	1	4
B047/0	€ 669,00	0	47	1,005	-	1
				1,01±1,2	0,01	20
				1,3±1,9	0,1	7
				1±9	1	9
				10±100	10	10
B047/1	€ 396,00	1	47	1,005	-	1
				1,01±1,2	0,01	20
				1,3±1,9	0,1	7
				1±9	1	9
				10±100	10	10
B047/2	€ 235,00	2	47	1,005	-	1
				1,01±1,2	0,01	20
				1,3±1,9	0,1	7
				1±9	1	9
				10±100	10	10
B087/0	€ 1120,00	0	87	1,001±1,009	0,001	9
				1,01±1,49	0,01	49
				0,5±9,5	0,5	19
				10±100	10	10
				B087/1	€ 597,00	1
1,01±1,49	0,01	49				
0,5±9,5	0,5	19				
10±100	10	10				
B087/2	€ 365,00	2	87			
				1,01±1,49	0,01	49
				0,5±9,5	0,5	19
				10±100	10	10
				B103/0	€ 1280,00	0
1,01±1,49	0,01	49				
0,5±24,5	0,5	49				
25±100	25	4				
B103/1	€ 792,00	1	103			
				1,01±1,49	0,01	49
				0,5±24,5	0,5	49
				25±100	25	4
				B103/2	€ 447,00	2
1,01±1,49	0,01	49				
0,5±24,5	0,5	49				
25±100	25	4				
B112/0	€ 1120,00	0	112			
				1,001 ± 1,009	0,001	9
				1,01 ± 1,49	0,01	49
				0,5 ± 24,5	0,5	49
				25 ± 100	25	4
B112/1	€ 791,00	1	112	1,005	-	1
				1,001 ± 1,009	0,001	9
				1,01 ± 1,49	0,01	49
				0,5 ± 24,5	0,5	49
				25 ± 100	25	4





**C025-**

**CALIBRO TAMPONE LISCIO H7 P/NP TEMPERATO E CEMENTATO**



Art.	€	Ø	Pezzi
C025/03	€ 37,60	3 mm	1
C025/04	€ 37,60	4 mm	1
C025/05	€ 37,60	5 mm	1
C025/06	€ 37,60	6 mm	1
C025/07	€ 37,60	7 mm	1
C025/08	€ 37,60	8 mm	1
C025/09	€ 37,60	9 mm	1
C025/10	€ 37,60	10 mm	1
C025/11	€ 46,60	11 mm	1
C025/12	€ 46,60	12 mm	1
C025/13	€ 46,60	13 mm	1
C025/14	€ 46,60	14 mm	1
C025/15	€ 46,60	15 mm	1
C025/16	€ 46,60	16 mm	1
C025/17	€ 46,60	17 mm	1
C025/18	€ 46,60	18 mm	1
C025/19	€ 46,60	19 mm	1
C025/20	€ 46,60	20 mm	1
C025/21	€ 69,80	21 mm	1
C025/22	€ 69,80	22 mm	1
C025/23	€ 69,80	23 mm	1
C025/24	€ 69,80	24 mm	1
C025/25	€ 69,80	25 mm	1
C025/26	€ 69,80	26 mm	1
C025/27	€ 69,80	27 mm	1
C025/28	€ 69,80	28 mm	1
C025/29	€ 69,80	29 mm	1
C025/30	€ 87,50	30 mm	1
C025/32	€ 87,50	32 mm	1
C025/33	€ 87,50	33 mm	1
C025/34	€ 87,50	34 mm	1
C025/35	€ 87,50	35 mm	1
C025/36	€ 87,50	36 mm	1
C025/37	€ 87,50	37 mm	1
C025/38	€ 87,50	38 mm	1
C025/40	€ 87,50	40 mm	1
C025/42	€ 87,50	42 mm	1
C025/44	€ 87,50	44 mm	1
C025/45	€ 98,30	45 mm	1
C025/46	€ 98,40	46 mm	1
C025/47	€ 98,40	47 mm	1
C025/48	€ 98,40	48 mm	1
C025/50	€ 98,40	50 mm	1
C025/51	€ 106,00	51 mm	1
C025/52	€ 106,00	52 mm	1
C025/55	€ 106,00	55 mm	2
C025/56	€ 106,00	56 mm	2
C025/57	€ 106,00	57 mm	2
C025/58	€ 106,00	58 mm	2
C025/59	€ 106,00	59 mm	2
C025/60	€ 106,00	60 mm	2
C025/62	€ 127,00	62 mm	2
C025/63	€ 127,00	63 mm	2
C025/65	€ 127,00	65 mm	2
C025/66	€ 127,00	66 mm	2
C025/67	€ 127,00	67 mm	2
C025/68	€ 127,00	68 mm	2
C025/69	€ 127,00	69 mm	2
C025/70	€ 169,00	70 mm	2
C025/71	€ 169,00	71 mm	2
C025/72	€ 169,00	72 mm	2
C025/74	€ 169,00	74 mm	2
C025/75	€ 169,00	75 mm	2
C025/76	€ 169,00	76 mm	2
C025/78	€ 169,00	78 mm	2
C025/80	€ 169,00	80 mm	2

**C025-3x**

**SERIE CALIBRI TAMPONE LISCI PASSA NON PASSA H7 TEMPERATI**



**UPGRADE**



Valigetta

Art.	€	Pezzi	Passo	Ø
C025/3/30	€ 1190,00	28	1 mm	3 ÷ 30 mm
C025/32/62	€ 1420,00	16	-	32-35-37-38-40-42-45-47-48-50 52-55-56-58-60-62 mm

**A015-**

**ANELLO DI AZZERAMENTO**

Precisione 6g.



2250

Art.	€	Misura
A015/008	€ 57,00	8 mm
A015/010	€ 63,90	10 mm
A015/011	€ 63,90	11 mm
A015/017	€ 69,80	17 mm
A015/025	€ 69,80	25 mm
A015/035	€ 69,80	35 mm
A015/040	€ 119,00	40 mm
A015/062	€ 132,00	62 mm
A015/087	€ 311,00	87 mm
A015/100	€ 327,00	100 mm
A015/125	€ 506,00	125 mm
A015/150	€ 710,00	150 mm

**T048x**
**TAMPONE FILETTATO DOPPIO P/NP**

Passo gas cilindrico.



Art.	€	Dimensioni
T0481/8	€ 70,80	1/8" - 28 TPI
T0481/4	€ 70,80	1/4" - 19 TPI
T0483/8	€ 70,80	3/8" - 19 TPI
T0481/2	€ 91,10	1/2" - 14 TPI
T0485/8	€ 106,00	5/8" - 14 TPI
T0483/4	€ 113,00	3/4" - 14 TPI
T0487/8	€ 147,00	7/8" - 14 TPI
T0481	€ 172,00	1" - 11 TPI

**T049x**
**TAMPONE FILETTATO DOPPIO P/NP METRICO 6H**

Art.	€	Dimensioni
T0493X0.5	€ 64,90	3 x 0,5 mm
T0494X0.7	€ 83,50	4 x 0,7 mm
T0495X0.8	€ 86,40	5 x 0,8 mm
T0496X1	€ 86,40	6 x 1 mm
T0498X1	€ 78,70	8 x 1 mm
T0498X1.25	€ 78,70	8 x 1,25 mm
T04910X1	€ 80,50	10 x 1 mm
T04910X1.25	€ 80,50	10 x 1,25 mm
T04910X1.5	€ 80,50	10 x 1,5 mm
T04912X1.25	€ 80,50	12 x 1,25 mm
T04912X1.5	€ 80,50	12 x 1,5 mm
T04912X1.75	€ 80,50	12 x 1,75 mm
T04914X1.5	€ 86,40	14 x 1,5 mm
T04914X2	€ 86,40	14 x 2 mm
T04916X1.5	€ 90,20	16 x 1,5 mm
T04916X2	€ 90,20	16 x 2 mm
T04918X1.5	€ 66,90	18 x 1,5 mm
T04918X2.5	€ 66,90	18 x 2,5 mm
T04920X1.5	€ 73,30	20 x 1,5 mm
T04920X2.5	€ 73,30	20 x 2,5 mm
T04922X1.5	€ 75,10	22 x 1,5 mm
T04922X2.5	€ 75,10	22 x 2,5 mm
T04924X1.5	€ 78,70	24 x 1,5 mm
T04924X2	€ 78,70	24 x 2 mm
T04924X3	€ 78,70	24 x 3 mm

**A018x**
**ANELLO FILETTATO TIPO PASSA**

Passo gas cilindrico.



Art.	€	Dimensioni
A0181/8	€ 73,00	1/8" - 28 TPI
A0181/4	€ 73,00	1/4" - 19 TPI
A0183/8	€ 73,00	3/8" - 19 TPI
A0181/2	€ 100,00	1/2" - 14 TPI
A0185/8	€ 100,00	5/8" - 14 TPI
A0183/4	€ 122,00	3/4" - 14 TPI
A0187/8	€ 147,00	7/8" - 14 TPI
A0181	€ 107,00	1" - 11 TPI

**A017x**
**ANELLO FILETTATO 6G TIPO PASSA METRICO**

Art.	€	Dimensioni
A0173X0.5	€ 62,90	3 x 0,5 mm
A0174X0.7	€ 70,80	4 x 0,7 mm
A0175X0.8	€ 70,80	5 x 0,8 mm
A0176X1	€ 58,90	6 x 1 mm
A0178X1	€ 58,90	8 x 1 mm
A0178X1.25	€ 58,90	8 x 1,25 mm
A01710X1	€ 83,50	10 x 1 mm
A01710X1.25	€ 64,90	10 x 1,25 mm
A01710X1.5	€ 64,90	10 x 1,5 mm
A01712X1.25	€ 90,20	12 x 1,25 mm
A01712X1.5	€ 90,20	12 x 1,5 mm
A01712X1.75	€ 90,20	12 x 1,75 mm
A01714X2	€ 90,20	14 x 2 mm
A01716X1.5	€ 95,60	16 x 1,5 mm
A01716X2	€ 95,60	16 x 2 mm
A01718X1.5	€ 66,90	18 x 1,5 mm
A01718X2.5	€ 66,90	18 x 2,5 mm
A01720X1.5	€ 70,60	20 x 1,5 mm
A01720X2.5	€ 70,60	20 x 2,5 mm
A01722X1.5	€ 80,40	22 x 1,5 mm
A01722X2.5	€ 80,40	22 x 2,5 mm
A01724X1.5	€ 107,00	24 x 1,5 mm
A01724X2	€ 107,00	24 x 2 mm
A01724X3	€ 107,00	24 x 3 mm

**S091**
**SERIE SPINE CALIBRATE**
**€ 520,00**

Valigetta

Pezzi	91
Misura	1±10 mm
Progressione	0,1 mm
Lunghezza	50 mm
Durezza	HRC-60-62
Precisione	±0,002 mm



**T009** € 35,00

**SUPPORTO TASTATORE AD ARCO**



Attacco maschio	Ø 8 mm
Attacco femmina	Ø 4 mm

**B201/1** € 18,20

**BASE MAGNETICA**

Per porta comparatore, materiale magnetico n35, selettore in abs e base prismatica.



Dimensioni base	36 x 30 x 35 mm
Foro	M5 x 0,8
Forza magnetica	300 N



**B201/2** € 21,60

**BASE MAGNETICA**

Per porta comparatore, materiale magnetico n35, selettore in abs e base prismatica.



Dimensioni base	60 x 50 x 55 mm
Foro	M8 x 1,25
Forza magnetica	800 N



**B201/3** € 28,50

**BASE MAGNETICA**

Per porta comparatore, materiale magnetico n35, selettore in abs e base prismatica.



Dimensioni base	73 x 50 x 55 mm
Foro	M8 x 1,25
Forza magnetica	1000 N



**B201/4** € 39,80

**BASE MAGNETICA**

Per porta comparatore, materiale magnetico n35, selettore in abs e base prismatica.



Dimensioni base	117 x 50 x 55 mm
Foro	M8 x 1,25
Forza magnetica	1300 N



**B100** € 26,00

**BASE MAGNETICA**

Per porta comparatore, selettore in abs e base prismatica.



Dimensioni	63 x 50 x 55h mm
Foro	M 8 x 1,25
Forza magnetica	600 N



**S052/2** € 34,20

**SUPPORTO MAGNETICO PORTA COMPARATORE**

Con regolazione micrometrica, colonna robusta e braccio trasversale regolabile. Base magnetica con appoggio prismatico e commutatore.



Asta principale	Ø 12 x 176 mm
Asta secondaria	Ø 10 x 150 mm
Forza magnetica	800 N
Dimensioni base	60 x 50 x 55 mm



**S052/3** € 59,30

**SUPPORTO MAGNETICO PORTA COMPARATORE**

Con regolazione micrometrica, colonna robusta e braccio trasversale regolabile. Base magnetica con appoggio prismatico e commutatore.



Asta principale	Ø 16 x 225 mm
Asta secondaria	Ø 14 x 165 mm
Forza magnetica	1000 N
Dimensioni base	73 x 50 x 55 mm



**S052/4**
**€ 87,80**
**SUPPORTO MAGNETICO PORTA COMPARATORE**

Con regolazione micrometrica, colonna robusta e braccio trasversale regolabile. Base magnetica con appoggio prismatico e commutatore.



Scatola

Asta principale	ø 20 x 355 mm
Asta secondaria	ø 14 x 210 mm
Forza magnetica	1300 N
Dimensioni base	117 x 50 x 55 mm

**S049**
**€ 38,60**
**SUPPORTO MAGNETICO PORTA COMPARATORE**

Con regolazione micrometrica.



Scatola

Asta principale	ø 12 x 170 mm
Asta secondaria	ø 10 x 150 mm
Forza magnetica	600 N
Dimensioni base	63 x 50 x 55h mm

**S047**
**€ 72,30**
**SUPPORTO MAGNETICO PORTA COMPARATORE**

Con regolazione micrometrica.



Scatola

Asta principale	ø 16 x 220 mm
Asta secondaria	ø 12 x 180 mm
Forza magnetica	800 N
Dimensioni base	65 x 50 x 55h mm

**S054**
**€ 35,00**
**SUPPORTO MAGNETICO PORTA COMPARATORE**

Con regolazione micrometrica.



Scatola

Asta principale	ø 12 x 170 mm
Asta secondaria	ø 10 x 165 mm
Forza magnetica	600 N
Dimensioni base	63 x 50 x 55h mm

**S055**
**€ 68,30**
**SUPPORTO MAGNETICO PORTA COMPARATORE**
**S042/1**
**€ 63,10**
**SUPPORTO ARTICOLATO MECCANICO**

Con bloccaggio centrale 3d delle aste.



Scatola

Asta principale	ø 16 x 210 mm
Asta secondaria	ø 12 x 175 mm
Forza magnetica	800 N
Dimensioni base	75 x 50 x 55h mm



Scatola

Dimensioni base	36 x 30 x 35 mm
Forza magnetica	300 N
Lunghezza braccio	145 mm

**S042/2**
**€ 79,80**
**SUPPORTO ARTICOLATO MECCANICO**

Con microregolazione e bloccaggio centrale 3d delle aste.



Scatola

Dimensioni base	60 x 50 x 55 mm
Forza magnetica	800 N
Lunghezza braccio	290 mm



Scatola

Dimensioni base	75 x 50 x 55 mm
Forza magnetica	1000 N
Lunghezza braccio	365 mm



**S045**

€ 81,00

**SUPPORTO ARTICOLATO MECCANICO**

Scatola

Asta principale	Ø 12 x 160 mm
Asta secondaria	Ø 10 x 180 mm
Forza magnetica	600 N
Dimensioni base	63 x 50 x 55h mm

**S046**

€ 124,00

**SUPPORTO ARTICOLATO IDRAULICO**

Scatola

Asta principale	Ø 17 x 180 mm
Asta secondaria	Ø 14 x 200 mm
Forza magnetica	600 N
Dimensioni base	63 x 50 x 55h mm

**B025**

€ 239,00

**STATIVO PORTA COMPARATORE**

Con piano scanalato e base in alluminio.



Scatola

Porta comparatore	Ø 8 mm
Dimensioni piano	80 x 80 mm
Dimensioni base	150 x 100 mm
Colonna	Ø 25 x 180 mm

**B010**

€ 295,00

**STATIVO PORTA COMPARATORE**

Con base in granito.



Scatola

Porta comparatore	Ø 8 mm
Dimensioni base	300 x 200 x 50h mm
Colonna	Ø 35 x 300 mm
Planarità base	0,002 mm

**A019-****APPARECCHIO A DUE PUNTE PER IL CONTROLLO DELLA CONCENTRICITÀ**

Con superfici di scorrimento rettificate e dotato di supporto porta comparatore.



Cassa di legno



Ghisa



Art.	€	Distanza tra le punte	Altezza punte Min. - Max	CM	Dimensioni	Porta comparatore	Peso netto
A019/300	€ 1340,00	300 mm	145 / 175 mm	2	730 x 310 x 370h mm	2	65 kg
A019/500	€ 1710,00	500 mm	135 / 170 mm	2	924 x 330 x 482h mm	2	70 kg
A019/1000	€ 2020,00	1000 mm	135 / 170 mm	2	1400 x 330 x 430h mm	2	100 kg

**S051**

€ 34,60

**SUPPORTO MICROMETRO**

Con ganasce ricoperte di plastica morbida.



Scatola



Ghisa



**P04x**

**PIANO DI RISCONTRO IN GRANITO**

Grado 0



Cassa di legno

Art.	€	Dimensioni	Peso netto
P040	€ 96,10	310 x 230 x 80 mm	20 kg
P042	€ 308,00	630 x 400 x 100 mm	80 kg
P043	€ 825,00	1000 x 630 x 150 mm	280 kg
P047	€ 1370,00	1200 x 800 x 160 mm	497 kg
P044	€ 2900,00	1600 x 1000 x 200 mm	1059 kg



**S06x**

**SQUADRA DI RISCONTRO IN GRANITO**

Grado 0



Cassa di legno



876

Art.	€	Dimensioni	Precisione
S061	€ 458,00	250 x 40 x 400h mm	± 6 µm
S062	€ 646,00	400 x 100 x 635h mm	± 9 µm

**S050-**

**SQUADRA A 90°**

Adatta per il controllo di ortogonalità e planarità nell'industria meccanica di precisione. Con cappello



Acciaio



875/1

Art.	€	Dimensioni	Sezione
S050/150	€ 36,80	150 x 100 mm	25,5 x 4,8 mm
S050/200	€ 46,70	200 x 130 mm	30,3 x 6 mm
S050/250	€ 62,40	250 x 165 mm	35 x 7 mm
S050/300	€ 69,50	300 x 200 mm	36 x 9 mm
S050/400	€ 154,00	400 x 265 mm	39 x 9 mm
S050/500	€ 184,00	500 x 330 mm	50 x 9 mm

**S051-**

**SQUADRA A 90°**

Adatta per il controllo di ortogonalità e planarità nell'industria meccanica. Con cappello



Acciaio

Art.	€	Dimensioni	Sezione
S051/100	€ 15,70	100 x 70 mm	20 x 5,5 mm <sup>2</sup>
S051/150	€ 18,10	150 x 100 mm	20 x 5,5 mm <sup>2</sup>
S051/200	€ 24,80	200 x 130 mm	20 x 5,5 mm <sup>2</sup>
S051/250	€ 28,60	250 x 160 mm	25 x 5,5 mm <sup>2</sup>
S051/300	€ 36,90	300 x 175 mm	25 x 5,5 mm <sup>2</sup>
S051/400	€ 40,60	400 x 200 mm	29,5 x 5,5 mm <sup>2</sup>
S051/500	€ 62,40	500 x 250 mm	29,5 x 5,5 mm <sup>2</sup>
S051/600	€ 78,50	600 x 330 mm	29,5 x 5,5 mm <sup>2</sup>
S051/750	€ 185,00	750 x 375 mm	29,5 x 5,5 mm <sup>2</sup>
S051/1000	€ 221,00	1000 x 500 mm	29,5 x 5,5 mm <sup>2</sup>

**S059-**

**SQUADRA A 90°**

Adatta per il controllo di ortogonalità e planarità nell'industria meccanica. Senza cappello



Acciaio

Art.	€	Dimensioni	Sezione
S059/100	€ 9,10	100 x 70 mm	20 x 5,5 mm <sup>2</sup>
S059/150	€ 10,90	150 x 100 mm	20 x 5,5 mm <sup>2</sup>
S059/200	€ 12,70	200 x 130 mm	20 x 5,5 mm <sup>2</sup>
S059/250	€ 15,30	250 x 160 mm	25 x 5,5 mm <sup>2</sup>
S059/300	€ 17,50	300 x 175 mm	25 x 5,5 mm <sup>2</sup>
S059/400	€ 22,20	400 x 200 mm	29,5 x 5,5 mm <sup>2</sup>
S059/500	€ 26,40	500 x 250 mm	29,5 x 5,5 mm <sup>2</sup>
S059/600	€ 31,70	600 x 330 mm	29,5 x 5,5 mm <sup>2</sup>
S059/750	€ 54,40	750 x 375 mm	29,5 x 5,5 mm <sup>2</sup>
S059/1000	€ 79,30	1000 x 500 mm	29,5 x 5,5 mm <sup>2</sup>

**S048-**

**SQUADRA BISELLATA A 90°**



875/00

Art.	€	Dimensioni	Sezione
S048/100	€ 39,10	100 x 70 mm	20 x 5 mm <sup>2</sup>
S048/150	€ 59,30	150 x 100 mm	25 x 5 mm <sup>2</sup>

**S056-**

**SQUADRA MAGNETICA A 90°**



Scatola

Art.	€	Dimensioni	Forza magnetica max.
S056/150	€ 90,30	150 x 150 x 50 mm	500 N
S056/200	€ 113,00	200 x 200 x 50 mm	1000 N

**S057/125**

**POSIZIONATORE MAGNETICO**

€ 21,00



Blister

Dimensioni	135 x 135 x 25 mm
Forza magnetica	340 N
Angolo di posizionamento	45 - 90 - 135°

**0286-**

**SQUADRA FALEGNAME MILLIMETRATA**



Art.	€	Dimensioni
0286/250	€ 3,11	250 x 130 x 0,8 mm
0286/300	€ 3,66	300 x 130 x 0,8 mm
0286/350	€ 4,08	350 x 155 x 0,8 mm

**S058**

**SQUADRA MAGNETICA INCLINABILE**

€ 104,00



Scatola

Dimensioni	115 x 115 x 35 mm
Gradi	45° ± 90°
Forza magnetica max.	250 N

**S057/060S**

**SERIE POSIZIONATORI MAGNETICI**

€ 14,20



4 Pcs



Blister

Dimensioni	50 x 60 x 12,5 mm
Forza magnetica	45 N
Angolo di posizionamento	45 - 90 - 135°

**0212 € 8,80**

**SPESSIMETRO**



Blister

Lame num.	20
Misure	0,05 - 1,00 mm

**FGx-AI**

**SET DI SPESSIMETRI IN ACCIAIO INOX**

Lame a forma conica, custodia placcata in nichel con dado di bloccaggio, misure in mm e pollici su ogni lama.



Blister

**INOX**

Art.	€	Lame num.	Tolleranza	Misure	Lunghezza lama
FG01/AI	€ 14,40	13	T2	0,05 - 1,00 mm   0,002 - 0,040"	100 mm
FG02/AI	€ 22,90	20	T2	0,05 - 1,00 mm   0,002 - 0,040"	100 mm

**HT125 € 7,70**

**SUPPORTO PER SPESSIMETRO A NASTRO**



Blister

Dimensioni	125 x 17 mm
------------	-------------



**FGx**

**SET DI SPESSIMETRI**

Lame a forma conica, custodia placcata in nichel con dado di bloccaggio, misure in mm e pollici su ogni lama.



Blister



Acciaio

Art.	€	Lame num.	Tolleranza	Misure	Lunghezza lama
FG01	€ 4,85	13	T2	0,05 - 1,00 mm   0,002 - 0,040"	100 mm
FG02	€ 8,20	20	T2	0,05 - 1,00 mm   0,002 - 0,040"	100 mm

**TGx-AE**

**SPESSIMETRO A NASTRO CONTINUO**

Misura in mm e pollici su ogni lama. Tolleranza T2



Blister



Acciaio

Art.	€	Spessore	Lunghezza
TG001/AE	€ 66,80	0.01 mm   0.0004"	5 m
TG002/AE	€ 51,80	0.02 mm   0.0008"	5 m
TG003/AE	€ 28,50	0.03 mm   0.0012"	5 m
TG004/AE	€ 29,60	0.04 mm   0.0016"	5 m
TG005/AE	€ 20,70	0.05 mm   0.0020"	5 m
TG006/AE	€ 20,70	0.06 mm   0.0024"	5 m
TG007/AE	€ 20,70	0.07 mm   0.0028"	5 m
TG008/AE	€ 20,70	0.08 mm   0.0030"	5 m
TG009/AE	€ 20,70	0.09 mm   0.0035"	5 m
TG010/AE	€ 20,70	0.10 mm   0.0040"	5 m
TG012/AE	€ 20,70	0.12 mm   0.005"	5 m
TG015/AE	€ 19,10	0.15 mm   0.006"	5 m
TG018/AE	€ 20,70	0.18 mm   0.007"	5 m
TG020/AE	€ 19,10	0.20 mm   0.008"	5 m
TG025/AE	€ 19,10	0.25 mm   0.010"	5 m
TG030/AE	€ 19,10	0.30 mm   0.012"	5 m
TG035/AE	€ 20,70	0.35 mm   0.014"	5 m
TG040/AE	€ 20,70	0.40 mm   0.016"	5 m
TG045/AE	€ 20,70	0.45 mm   0.018"	5 m
TG050/AE	€ 20,70	0.50 mm   0.020"	5 m
TG055/AE	€ 29,60	0.55 mm   0.022"	5 m
TG060/AE	€ 29,60	0.60 mm   0.024"	5 m
TG065/AE	€ 29,60	0.65 mm   0.026"	5 m
TG070/AE	€ 25,50	0.70 mm   0.028"	5 m
TG075/AE	€ 25,50	0.75 mm   0.030"	5 m
TG080/AE	€ 25,50	0.80 mm   0.032"	5 m
TG085/AE	€ 25,50	0.85 mm   0.034"	5 m
TG090/AE	€ 25,50	0.90 mm   0.036"	5 m
TG095/AE	€ 25,50	0.95 mm   0.038"	5 m
TG100/AE	€ 25,50	1.00 mm   0.040"	5 m
TG110/AE	€ 19,40	1.10 mm	1 m
TG120/AE	€ 19,40	1.20 mm	1 m
TG130/AE	€ 19,40	1.30 mm	1 m
TG140/AE	€ 19,40	1.40 mm	1 m
TG150/AE	€ 19,40	1.50 mm	1 m
TG160/AE	€ 19,40	1.60 mm	1 m
TG170/AE	€ 19,40	1.70 mm	1 m
TG180/AE	€ 19,40	1.80 mm	1 m
TG190/AE	€ 19,40	1.90 mm	1 m
TG200/AE	€ 19,40	2.00 mm	1 m



**C058**

€ 14,00

**CONTAFILETTI A 58 LAME**

Blister

Lame metriche	0.25 - 6 mm 60°
Lame a pollici	4 - 62 TPI 55°
Lame a gas	8 - 28 TPI 55°

**C029-****COMPASSO**

Per interni.



Art.	€	Lunghezza
C029/150	€ 9,70	150 mm
C029/200	€ 12,00	200 mm
C029/250	€ 13,90	250 mm
C029/300	€ 16,40	300 mm

**C027-****COMPASSO**

Con guida e gambo quadrato.



Art.	€	Lunghezza
C027/150	€ 13,50	150 mm
C027/200	€ 15,90	200 mm
C027/250	€ 19,80	250 mm
C027/300	€ 22,00	300 mm

**C026-****COMPASSO**

A punta con gambo quadrato.



Art.	€	Lunghezza
C026/150	€ 9,70	150 mm
C026/200	€ 12,00	200 mm
C026/250	€ 16,40	250 mm
C026/300	€ 18,90	300 mm

**C028-****COMPASSO**

Per spessori esterni.



Art.	€	Lunghezza
C028/150	€ 9,70	150 mm
C028/200	€ 12,00	200 mm
C028/250	€ 13,90	250 mm
C028/300	€ 16,40	300 mm



**P007-**
**PRISMA MAGNETICO**

Singolo o in coppia.



Scatola

Art.	€	Dimensioni	Larghezza	Forza magnetica max.	Pezzi
P007/1	€ 123,00	70 x 60 x 72 mm	38 mm	400 N	1
P007/2	€ 158,00	100 x 70 x 95 mm	50 / 16 mm	300 N	1
P007/1C	€ 234,00	71 x 60 x 73 mm	38 mm	400 N	2
P007/2C	€ 360,00	100 x 70 x 95 mm	50 / 16 mm	300 N	2

**P30x**
**PRISMA A 90°**

Con morsetto, singolo o in coppia.



Scatola



Acciaio



Temprato

Art.	€	Dimensioni	Bloccaggio massimo	Precisione	Pezzi
P301/2	€ 68,90	63,5 x 63,5 x 50 mm	ø 35 mm	±0,01 mm	1
P302/2	€ 117,00	100 x 75 x 75 mm	ø 65 mm	±0,01 mm	1
P303/2	€ 181,00	150 x 125 x 100 mm	ø 110 mm	±0,01 mm	1
P301/2C	€ 133,00	63,5 x 63,5 x 50,8 mm	ø 35 mm	±0,01 mm	2
P302/2C	€ 230,00	100 x 75 x 75 mm	ø 65 mm	±0,01 mm	2
P303/2C	€ 361,00	150 x 125 x 100 mm	ø 110 mm	±0,01 mm	2

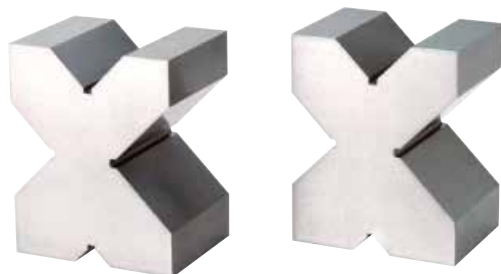
**P20x**
**COPPIA PRISMI RETTIFICATI**

Scatola

**C45**

Art.	€	Dimensioni	Precisione
P200/1	€ 251,00	75 x 75 x 60 mm	1/100 mm
P201/1	€ 334,00	100 x 80 x 60 mm	1/100 mm

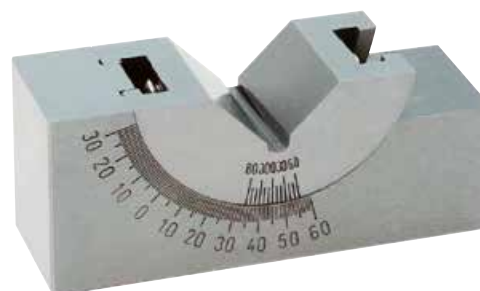
**P011-**
**PRISMA INCLINABILE**

Scatola

Art.	€	Dimensioni
P011/075	€ 116,00	75 x 32 x 25 mm
P011/100	€ 138,00	102 x 48 x 46 mm



**F813**

€ 4,90 **NEW**

**FLESSOMETRO**



Espositore

Dimensioni nastro 3 m x 12 mm  
Classe di precisione II

**F2Gx**

**FLESSOMETRO**

Con meccanismo di arresto in acciaio, gancio rivettato all'estremità con protezione della lama inferiore mediante ammortizzatore.



Espositore

Art.	€	Dimensioni nastro	Classe di precisione
F2G2	€ 3,58	2 m x 16 mm	II
F2G3	€ 4,09	3 m x 16 mm	II
F2G5	€ 6,30	5 m x 19 mm	II

**F68x**

**FLESSOMETRO MAGNETICO**

Con meccanismo di arresto in acciaio, gancio rivettato all'estremità con protezione della lama inferiore mediante ammortizzatore.



Espositore

Art.	€	Dimensioni nastro	Classe di precisione
F683	€ 6,70	3 m x 19 mm	II
F685	€ 9,30	5 m x 25 mm	II
F688	€ 13,40	8 m x 25 mm	II

**F80x**

**FLESSOMETRO**

Di forma ergonomica antiscivolo, con bloccaggio sicuro e preciso, gancio per cintura, nastro di spessore maggiorato con rivestimento in poliestere antiabrasivo.



Espositore

Art.	€	Dimensioni nastro	Classe di precisione
F802	€ 2,83	2 m x 16 mm	II
F803	€ 4,60	3 m x 16 mm	II
F805	€ 6,50	5 m x 19 mm	II
F808	€ 9,30	8 m x 25 mm	II

**F32x**

**FLESSOMETRO MAGNETICO**

Con freno automatico e magnete.



Espositore

Art.	€	Dimensioni nastro	Classe di precisione
F322	€ 4,61	2 m x 16 mm	II
F323	€ 6,10	3 m x 19 mm	II
F325	€ 8,30	5 m x 25 mm	II
F328	€ 11,60	8 m x 25 mm	II

**R0x**
**ROTELLA METRICA**

Con nastro in acciaio.



Scatola

Art.	€	Dimensioni nastro
R030	€ 28,10	30 m x 13 mm
R050	€ 43,60	50 m x 13 mm

**0449**
**€ 25,60**
**MINI LIVELLA LASER**

A 4 fiale, con corpo in ABS, raggio laser in grado di emettere un unico punto o una croce perpendicolare.



Scatola

Tipo laser	Classe II / 650 nm
Distanza di lavoro	20 m
Potenza	< 1 mW
Accuratezza	0,05°
Batteria	2 x 1,5V AAA

**0109**
**€ 52,70**
**LIVELLA DIGITALE**

Magnetica con corpo in alluminio, autospegnimento, schermo retroilluminato, 2 fiale, lettura assoluta e relativa, funzione "hold".



Scatola

Lunghezza	400 mm
Autospegnimento	5 min
Gamma di misurazione	0 - 90° x 4
Risoluzione	0° - 90°: 0,1°
Precisione livella	0° - 90°: ±0,2°
Batteria	2 x AAA 1,5V

**0646/A**
**€ 128,00**
**LASER AUTOLIVELLANTE**

Scatola

Precisione di livellamento	0,5 mm / m
Precisione linea orizzontale e verticale	± 0,5 mm / m
Batteria	3 x 1,5V AA
Tipo laser	Classe II / 650 nm
Distanza di lavoro consigliata	10 m
H massima	126,5 cm
H minima	52,5 cm

**0666**
**€ 193,00**
**LIVELLA DIGITALE CON RAGGIO LASER**

Visualizzazione dell'angolo o della percentuale di inclinazione. Batterie non incluse.



Scatola

Lunghezza	600 mm
Autospegnimento	5 min
Gamma di misurazione	0 - 360°
Lunghezza d'onda	650 nm
Risoluzione	0,1°
Potenza laser	< 1 mW
Precisione livella	± 0,05°
Precisione del punto	± 1 mm / m
Batteria	2 x 1,5V AAA

**0112**
**€ 115,00**
**LIVELLA DIGITALE**

Magnetica con corpo in alluminio e base fresata, autospegnimento, schermo retroilluminato, 2 fiale, funzione "hold", ricerca del 0° e 90° sonoro, lettura: assoluta e relativa, gradi, percentuale, mm/m e in/ft, borsa per il trasporto.



Scatola

Lunghezza	600 mm
Autospegnimento	5 min
Gamma di misurazione	0 - 90° x 4
Risoluzione	0° & 90°: 0,05°; 0° - 89°: 0,1°
Precisione livella	0° & 90°: ±0,05°; 0,1° - 89,9°: ±0,2°
Batteria	2 x AAA 1,5 V

**L090A**
**€ 120,00**
**LIVELLA DIGITALE INCLINOMETRO E GONIOMETRO CON MAGNETE**

Funzioni: 0 ÷ 90° in tutte le 4 direzioni, inclinazione mm/m, inclinazione in/ft, percentuale d'inclinazione (%), retroilluminazione, autospegnimento, misurazione assoluta (ABS) e relativa, inversione automatica dei numeri per letture sottosopra, con segnale acustico.



Scatola

Precisione	± 0.15°
Gamma di misurazione	0 ÷ 90° x 4
Risoluzione	0.05°
Dimensioni	151 x 31 x 60 mm
Batteria	2 x 1.5 V AAA

**L085**
**€ 91,70**
**LIVELLA QUADRA DIGITALE**

Magnetica 2 x 0 ÷ 180°, autospegnimento, misurazione assoluta (ABS) e relativa, inversione automatica dei numeri per letture sottosopra e funzione hold.



Blister



Precisione	± 0.1°
Gamma di misurazione	0° ÷ 180°
Risoluzione	0.1°
Dimensioni	51 x 51 x 33 mm
Batteria	1 x 3 V CR2032

**0824-**
**LIVELLA**

In alluminio a 3 fiale, fresata e millimetrata.



Art.	€	Dimensioni
0824/300	€ 6,10	300 x 49 x 23 mm
0824/400	€ 6,90	400 x 49 x 23 mm
0824/500	€ 8,10	500 x 49 x 23 mm
0824/600	€ 9,20	600 x 49 x 23 mm

**L080**
**€ 58,20**
**LIVELLA QUADRA DIGITALE**

Magnetica 0 ÷ 90° in tutte le 4 direzioni, retroilluminazione, autospegnimento, misurazione assoluta (ABS) e relativa, inversione automatica dei numeri per letture sottosopra.



Blister

Precisione	0° ± 0.1°; 90° ± 0.1°; 0.1° ÷ 89.9° ± 0.2°
Gamma di misurazione	0 ÷ 90° x 4
Risoluzione	0.1°
Dimensioni	59 x 27 x 59 mm
Batteria	1 x 1.5 V AAA

**0805/400**
**€ 10,00**
**LIVELLA MAGNETICA**

A 3 fiale millimetrata.



Dimensioni	400 x 50 x 20 mm
------------	------------------

**L200**
**€ 206,00**
**LIVELLA LINEARE**

Rettificata di alta precisione, con base prismatica.



Dimensioni	200 x 45 x 40 mm
Precisione	0,02 mm / m

**L150**

€ 239,00

**LIVELLA QUADRA**

Rettificata di alta precisione, con 2 facce piane e 2 prismatiche.



Dimensioni	150 x 38 x 150 mm
Precisione	0,02 mm / m

**G006-**

**GONIOMETRO SEMPLICE**

Con vite di bloccaggio, scala incisa al laser.

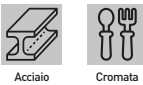

Art.	€	Arco	Asta	Campo di misura
G006/120	€ 23,00	Ø 80 mm	120 mm	0 ÷ 180°
G006/150	€ 25,80	Ø 120 mm	150 mm	0 ÷ 180°
G006/200	€ 31,30	Ø 150 mm	200 mm	0 ÷ 180°
G006/300	€ 43,90	Ø 200 mm	300 mm	0 ÷ 180°
G006/500	€ 90,50	Ø 300 mm	500 mm	0 ÷ 180°
G006/600	€ 103,00	Ø 300 mm	600 mm	0 ÷ 180°

**G008**

€ 55,90

**GONIOMETRO DIGITALE E LIVELLA CON 2 FIALE**

Calcolo automatico di angoli e inclinazioni.



Blister

Lunghezza	400 mm
Scala	0 ÷ 225°
Letture	0,1°
Accuratezza	± 0,5°
Batteria	1x 9V

**G005**

€ 93,60

**GONIOMETRO UNIVERSALE**



Letture	5'
Scala	0° ÷ 360°
Asta	300 mm



**E022/12**
**€ 382,00**
**ENDOSCOPIO FLESSIBILE PER MECCANICA**

Con sonda  $\varnothing$  12 mm dotato di: schermo a colori lcd 3,5" - sonda flessibile - videocamera dotata di luci Led - possono essere aggiunte fino a 2 prolunghe - terminale magnetico - terminale a gancio - terminale con specchio.



Valigetta

Lunghezza senza manico	900 mm
Sonda	$\varnothing$ 12 mm
Visione	0° - 60°
Batteria	1 x 9 V
Massima profondità di rilevazione	50 mm
Distanza	2.5 cm - 30 cm
Display	3.5" LCD
Tempo di utilizzo	> 2hr
Temperatura di esercizio	0°C - 4°C
Temperatura stoccaggio	-20°C - +60°C
Dimensioni	215 x 156 x 96 mm

**M072**
**€ 31,50**
**LENTE DI PRECISIONE PER MISURAZIONI**

Scatola

Ingrandimenti	10x
Campo di vista	24 mm
Campo di misura	0 ÷ 20 mm
Letture	0,1 mm

**E022/5**
**€ 382,00**
**SONDA FLESSIBILE**

Dimensioni	$\varnothing$ 5,5 mm
Lunghezza	1070 mm

**E022/P**
**€ 83,20**
**PROLUNGA FLESSIBILE**

Dimensioni	$\varnothing$ 18 mm
Lunghezza	2750 mm

**M069**
**€ 610,00**
**MICROSCOPIO STEREOSCOPICO**

Scatola

Luce propria diretta	12 V - 10 W
Distanza di lavoro	165 mm 10x - 119 mm 20x
Alimentazione	230 V 50 Hz
Oculari	10x - 20x
Obiettivi	1x - 2x
Ingrandimenti	10x ÷ 40x

**M071**
**€ 431,00**
**MICROSCOPIO STEREOSCOPICO**

Scatola

Luce propria incidente e diretta	12 V - 10 W
Altezza massima del pezzo da controllare	75 mm
Alimentazione	230 V 50 Hz
Oculari	10x
Obiettivi	2x - 4x
Ingrandimenti	20x ÷ 40x

**P080**
**€ 86,40**
**PINZA AMPEROMETRICA DIGITALE**

Con display LCD. 7 modalità di funzionamento: corrente AC, voltaggio AC, voltaggio in DC, resistenza, continuità, frequenza, controllo diodo. Alta affidabilità.



Scatola

ACV	4 / 40 / 400 / 600 V ±1,5% + 4
ACA	4 / 40 / 400 / 600 A ±1,5% + 4
DCV	4 / 40 / 400 / 600 V ±1,0% + 2
RES	400 Ω / 4 kΩ / 40 kΩ / 400 kΩ / 4 MΩ / 40 MΩ ±1,0% + 2
Frequenza	10 MHz ±0,8% + 2
Batteria	2 x 1,5 V x AA
Dimensioni	250 x 71 x 38,8 mm

**0029**
**€ 6,00**
**TESTER RUBACORRENTE**

Per rilevare la corrente nei cavi delle automobili, con valori di tensione da 6-12-24V.



Voltaggio	6 - 12 - 24 V
-----------	---------------

**0013/142**
**€ 1,80**
**GIRAVITE CERCAFASE**

Con impugnatura in materiale isolante, luce al neon e lama in acciaio.



Campo di misura	100 ÷ 500 V
Lunghezza	142 mm

**0013/185**
**€ 1,96**
**GIRAVITE CERCAFASE**

Con impugnatura in materiale isolante, luce al neon e lama in acciaio.



Campo di misura	100 ÷ 500 V
Lunghezza	190 mm

**P075**
**€ 145,00**
**PINZA AMPEROMETRICA DIGITALE**

Con display LCD. 9 modalità di funzionamento: corrente AC, voltaggio AC, voltaggio in DC, resistenza, continuità, frequenza, controllo diodo, misurazione della temperatura. Alta affidabilità.



Scatola

ACV	750 V ±1,2%
ACA	200 - 1000 A ±2,0%
DCV	1000 V ±1,0%
DCA	200 - 1000 A ±2,0%
RES	200 Ω ±1,0%
Frequenza	2k Hz ±2,5%
Temperatura	-40°C - 400°C ±1,5%
Batteria	1 x 9V

**T051**
**€ 20,60**
**MULTIMETRO DIGITALE TASCABILE**

Continuità sonora e controllo diodi.



Scatola

DCV	2-20-200-500V ±0,5%
ACV	200-500V ±1,2%
DCA	200mA ±1,5%
RES	2K-20K-200K-2M Ω ±1%
Batteria	1 x A23



**T050**
**€ 40,90**
**MULTIMETRO DIGITALE**

Con sonda per misurazione temperatura, continuità sonora e controllo diodi.



Scatola

DCV	200 mV ±0,5%
DCV	2 V - 20 V - 200 V ±0,8%
DCV	1000 V ±0,1%
ACV	2mV - 20 V - 200 V ±1,0%
ACV	750 V ±1,2%
DCA	2 mA - 20 mA ±1,8%
DCA	200 mA ±2,0%
DCA	20 A ±2,0%
ACA	200 mA ±2,0%
ACA	20 A ±3,0%
RES	200 Ω ±1,0%
RES	2KΩ - 20KΩ - 200KΩ - 2MΩ ±1,0%
RES	20 MΩ ± 1.0%
RES	200 MΩ ±5.0%
CAP	2000 pF - 20 nF - 200 nF - 2 μF - 20 μF ±4%
Temperatura	-40 °C ÷ 400 °C ±1,0%
Temperatura	400 °C ÷ 1000 °C ±1,5%
Batteria	1x 9V

**T053**
**€ 98,20**
**MULTIMETRO DIGITALE**

Con sonda per misurazione temperatura, continuità sonora e controllo diodi.



Scatola

DCV	200 mV - 2 V - 20 V - 200 V - 1000 V ±0,8%
ACV	200 mV - 2 V - 20 V - 750 V ±1,2%
DCA / ACA	200 μA - 2 mA - 20 mA - 200 mA - 20 A ±2,0%
RES	200Ω - 2kΩ - 20kΩ - 200kΩ - 2MΩ - 20MΩ - 200MΩ ±1%
CAP	20 nF / 200 nF / 2 μF / 20 μF / 200 μF / 2000 μF ±2,5%
Induttanza	2 mH - 20mH - 200 mH - 2 H - 20 H
Batteria	1x 9V
Temperatura	-20 °C ÷ 1000 °C
Frequenza	10 mHz
Test transistor hFE	0 ~ 1000

**ML80A**
**€ 88,90**
**MISURATORE DI DISTANZA LASER**

Maneggevole e leggero, ideale per misurazioni nell'edilizia e in carpenteria, funzioni: addizioni, sottrazioni, area e volume, autospegnimento.



Blister



Campo di misura	0,05 ÷ 80 m
Precisione	±2 mm
Batteria	3 x AAA

**ML40**
**€ 66,10**
**MISURATORE DI DISTANZA LASER**

Maneggevole e leggero, ideale per misurazioni in edilizia e in carpenteria, funzioni: addizioni, sottrazioni, area e volume, autospegnimento.



Blister



Campo di misura	0,05 ÷ 40 m
Precisione	± 2 mm
Batteria	2 x AAA

**T068**
**€ 144,00**
**MISURATORE DI TEMPERATURA AD INFRAROSSI CON PUNTATORE LASER**

Non idoneo alla misura della temperatura corporea.



Scatola

Campo di misura	-30°C÷550 °C   -22 F÷1022 F
Precisione	-30 °C ÷ 0 °C   -22 F ÷ 32 F ±3 % o ±3 °C
Precisione	0 °C ÷ 100 °C   32 F ÷ 212 F ±2 % o ±2 °C
Precisione	> 100 °C   > 212 F ±3 % o ±3 °C
Letture	0,1 °C   0,1 F
Emissività	0,1 ÷ 1,0
Batteria	1x 9V
Dimensioni	146 x 80 x 38 mm
Distanza / Diametro dell'area	1 : 12

**T057**
**€ 246,00**
**MISURATORE DIGITALE DI TEMPERATURA E UMIDITÀ AMBIENTE**

Alta precisione, con micro-computer LSI.



Valigetta

Temperatura	-10 °C ÷ +65 °C
Letture temperatura	0,1 °C
Precisione temperatura	±0,5 °C
Umidità relativa	10 % ÷ 100 %
Precisione	2 % ±1 % RH
Batteria	4 x 1,5 V AA
Tempo di risposta	0,4 s
Consumo di energia	16 mA
Dimensioni	202 x 72 x 37 mm

**T054**
**€ 40,90**
**MISURATORE DI TEMPERATURA DIGITALE TASCABILE**

Con sonde per rilevare la temperatura o per immersione.



Scatola

Letture	1 °C
Campo di misura	-50°C ÷ 1100°C con uso sonda T056/TP03 non in dotazione, -50°C ÷ 750°C con uso sonda T056/TP02 in dotazione, -50°C ÷ 250
Precisione	0°C ÷ 500°C ±(0,75% +1°C), 500°C ÷ 750°C ± (1% + 1°C), 750°C ÷ 1000°C ± (2% + 1°C), 1000°C ÷ 1200°C ± (4% + 3°C)
Sonda tipo	"K"
Batteria	1x 9V

**T064**
**€ 111,00**
**MISURATORE DI TEMPERATURA AD INFRAROSSI CON PUNTATORE LASER**

Alta precisione. Misurazione della temperatura senza contatto. Non idoneo per essere umani.



Blister

Campo di misura	-25°C÷400 °C   -13 F÷752 F
Precisione	-25 °C ÷ 400 °C ±(2 % + 1 °C)
Precisione	-13 F ÷ 752 F ±(2 % + 1 F)
Letture	1 °C   2 F
Batteria	1x 9V
Distanza / Diametro dell'area	1 : 10
Tempo di misurazione	0,5 s
Emissività pre- impostata	0,95

**I002**
**€ 359,00**
**IGROMETRO A CONTATTO PER LA MISURAZIONE DI UMIDITÀ**

Del legno e materiali da costruzione. Con Micro- Computer LSI e timer a cristalli per alta precisione. Collegamento computer per trasferimento dati. Non idoneo per misurare l'umidità ambientale.



Valigetta

Temperatura di esercizio	0 °C - 40 °C
Campo di misura	0 - 80 %
Materiali da costruzione	0 - 50 %
Letture	0,1 %
Precisione	± (0,5 % n+1)
Batteria	4 x 1,5 V AA
Dimensioni	165 x 62 x 26 mm

**T063**
**€ 74,00**
**MISURATORE DI TEMPERATURA DIGITALE PORTABILE**

Sonde tipo "K" per ambiente e per immersione, doppia rilevazione della temperatura, con scatola.



Scatola

Campo di misura	T056/TP01: -50°C ÷ 250°C
Campo di misura	T056/TP02: -50°C ÷ 750°C
Letture	1 °C
Precisione	-50 °C ÷ 1200 °C ±(0,3 % + 2 °C)
Precisione	1200°C ÷ 1300 °C ±(0,6 % + 2 °C)
Precisione	-58 F ~ 1200 F ±(0,3 % + 2 F)
Precisione	1200 F ~ 1999 F ±(0,6 % + 2 F)
Batteria	1x 9V

**T055 € 159,00**
**MISURATORE DI TEMPERATURA DIGITALE PORTATILE**

Sonde tipo "K" per ambiente e per immersione con custodia in plastica.



Scatola

Campo di misura	T056/TP01: -50°C ÷ 250°C
Campo di misura	T056/TP02: -50°C ÷ 750°C
Letture	0,1 F
Letture	0,1 °C
Precisione	±(0,3% n+1.8 F)
Precisione	±(0,3% n+1 °C)
Dimensioni	178 x 68 x 39 mm
Lunghezza totale sonda	120 mm
Batteria	4 x 1,5 VAA

**F010 € 338,00**
**FONOMETRO INTEGRATORE DIGITALE**

Alta precisione, modalità di rilevamento Fast, Slow, Max. Collegamento con computer per trasferimento dati.



Valigetta

Risposta di frequenze	31,5 Hz ÷ 8 kHz
Campo di misura	30 dB ÷ 130 dB (A)   32 dB ÷ 130 dB (C)   35 dB ÷ 130 dB (Lineare)
Letture	0,1 dB
Funzioni	SL, LN, Leq (livello equivalente)
Caratteristiche di rilevamento	Fast, Slow, Max
Tempo di misurazione	0,1 s
Display	10 mm
Temperatura di esercizio	-10 °C ÷ 40 °C
Batterie non incluse	4 x 1,5 V AAA
Tempo di risposta	1 s
Dimensioni	236 x 63 x 26 mm

**T056/TP01 € 9,70**
**SONDA TIPO "K" PER TEMPERATURA AMBIENTE**

Campo di misura	-50°C ÷ 250°C
Tipo sonda	"K"
Lunghezza sonda	2 mm

**T056/TP02 € 11,90**
**SONDA TIPO "K" PER TEMPERATURA AMBIENTE O PER IMMERSIONE**

Campo di misura	-50°C ÷ 750°C
Tipo sonda	"K"
Lunghezza totale	135 mm

**T056/TP03 € 70,70**
**SONDA TIPO "K"**

Per temperatura ambiente o per immersione.



Campo di misura	-50 °C ÷ 1100 °C
Tipo sonda	"K"
Lunghezza sonda	650 mm

**A005 € 226,00**
**ANEMOMETRO DIGITALE**

Valigetta

<b>MISURAZIONE VELOCITÀ DELL'ARIA</b>	
Unità di misura	m/s - Km/h - ft/min - Knots
Gamma velocità madrina	0,4 ÷ 30,0 / 1,4 ÷ 108 / 80 ÷ 5910 / 0,8 ÷ 58,3
Letture	0,1
Precisione	± (2%+1 cifra) / ± (2%+3 cifre) / ± (2%+2 cifre) / ± (2%+2 cifre)
<b>MISURAZIONE TEMPERATURA</b>	
Campo di misura	0°C÷60°C   32 F÷140 F
Letture	0,1° C   0,1 F
Precisione	0,5°C   0.9 F
Batteria	1x 9V non inclusa

**L014**
**€ 79,00**
**LUXMETRO DIGITALE**

Valigetta

Campo di misura	0 LUX ÷ 2000 LUX ÷ 20000 LUX ÷ 50000 LUX
Risoluzione	1 LUX
Precisione	± 5 %
Batteria	1x 9V

**MD01**
**€ 129,00**
**CERCAMETALLI**

Analogico composto da 2 Led a colori per riconoscimento metalli. Sensore audio.



Scatola

Diametro bobina	170 mm
Connettore jack	1/4"
Sensibilità	> 15 cm per una moneta di Ø 25 mm
Batteria	1x 9V

**C069**
**€ 121,00**
**CONTAGIRI DIGITALE A CONTATTO**

Valigetta

Velocità di rotazione	2,5 - 9999,9 rpm
Velocità tangenziale	0,05 - 999,99 m/min
Letture	0,1 (7,5 - 999,9) rpm
Letture	1 (1000-9999,9) rpm
Precisione	± 0,05% + 1 cifra
Dimensioni	190 x 72 x 37 mm
Batteria	4 x 1,5 V AA

**O387A**
**€ 74,00**
**RILEVATORE DIGITALE**

Per la misurazione di metalli ferrosi e non ferrosi, legno e cavi in tensione in pareti, soffitti e pavimenti.



Scatola

<b>Massima profondità di rilevazione</b>	
Metalli ferrosi	100 ± 5 mm
Metalli non ferrosi	70 ± 5 mm
Legno	20 ± 5 mm
Cavi in tensione	50 ± 5 mm
Batteria	1x 9V
Dimensioni	150 x 75 x 24 mm

**C070**
**€ 169,00**
**CONTAGIRI DIGITALE OTTICO E A CONTATTO**

Con strisce catodiottriche. Alta precisione.



Valigetta

Velocità di rotazione ottica	2,5 ÷ 9999,9 rpm
Velocità di rotazione contatto	0,05 ÷ 999,9 rpm
Velocità tangenziale	0,1 ÷ 999,99 m / min
Letture	0,1 (2,5 ÷ 999,9) rpm
Letture	1 (1000 ÷ 9999,9) rpm
Distanza d'uso	da 50 ÷ 60 mm a 50 ÷ 250 mm (con ottico)
Precisione	± 0,05% + 1 cifra
Dimensioni	220 x 75 x 29 mm
Batteria	4 x 1,5V AA
Temperatura di esercizio	0°C ÷ 40°C
Tempo di misurazione	0,8 s

**C067**
**€ 121,00**
**CONTAGIRI DIGITALE OTTICO**

Con strisce catodiottriche.



Valigetta

Campo di misura	2,5 ÷ 9999,9 rpm
Letture	0,1 (2,5 ÷ 999,9) rpm
Letture	1 (1000 ÷ 9999,9) rpm
Distanza d'uso	da 50 ÷ 60 mm a 50 ÷ 250 mm
Precisione	± 0,05% della lettura + 1 cifra
Dimensioni	170 x 72 x 37 mm
Batteria	4 x 1,5V AA

**0543** € 22,80

**MISURATORE DI PRESSIONE PNEUMATICI E EMERGENZA AUTO**

Ideale in condizioni di emergenza può essere utilizzato in 4 modi differenti: misuratore di pressione pneumatici, torcia elettrica a Led, martello rompi vetro di emergenza, taglia cintura di sicurezza.



Blister



Campo di misura	3÷150 psi   0,21÷10,34 bar   21÷1034 kPa
Temperatura di esercizio	-20°C ~ +50° C
Batteria	2x 1.5V AA

**V002** € 1190,00

**MISURATORE DI VIBRAZIONI**

Completo di sonda magnetica, 2 puntali, software e cavo usb.

Accelerazione	0,1 ÷ 400 m/s <sup>2</sup>
Velocità	0,01 ÷ 40 cm/s
Spostamento	0,001 ÷ 4 mm
Equilibratura rpm	60 ÷ 99,990
Frequenza	1÷20 kHz
Precisione	± 5 %
Batteria	4 x 1,5 V AA

**0836** € 19,00

**MISURATORE DI PRESSIONE DIGITALE**

Dotato di misuratore di spessore del battistrada e di luce al Led.



Blister



Campo di misura	0,5÷99,5 psi 0,034÷6,86 bar, 3,45÷686 kPa
Precisione	±1%
Batteria	3 x SR44

**S004** € 1630,00

**MISURATORE DI SPESSORI AD ULTRASUONI**

Risoluzione	4-digit LCD
Campo di misura	1,0 ÷ 225,0 mm
Precisione	±0,1 mm
Dimensioni	126 x 68 x 23 mm
Batteria	2 x 1,5 V AA

**0583** € 98,20

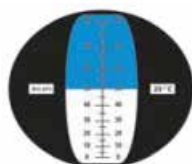
**RIFRATTOMETRO BRIX**

Valigetta

Campo di misura	0 ÷ 80 % Brix
-----------------	---------------

**0433** € 90,10

**RIFRATTOMETRO**

Brix per controllo di oli emulsionabili.



Valigetta

Campo di misura	0 ÷ 32% Brix
-----------------	--------------

**0312** € 98,20

**RIFRATTOMETRO TRIVALENTE PER LIQUIDI AUTO**

Valigetta

Scala per liquidi antigelo E	-50 °C ÷ 0 °C
Scala per liquidi antigelo P	-50 °C ÷ 0 °C
Scala per liquidi batteria B	1,10 ÷ 1,40 SG
Scala per liquidi tergilavaggio C	-40 ÷ 0°C

**0312/AB** € 73,60

**RIFRATTOMETRO PER LIQUIDI AUTO CON ADBLUE**

Valigetta

Scala per liquidi antigelo E	-40 °C ÷ 0 °C
Scala per liquidi antigelo P	-50 °C ÷ 0 °C
Scala per liquidi batteria B	1,10 ÷ 1,40 SG
AdBlue	30 ÷ 35 %

**D001**

€ 2670,00

**DUROMETRO DA BANCO ROCKWELL**

Cassa di legno

Letture	0,5 HR
Penetratore a diamante e a sfera	n° 1+1
Incudini piani	n° 2
Incudine a V	n° 1
Blocchetti di taratura	n° 5 (HRC, 3xHRB, HRA)
Altezza max del pezzo da misurare	170 mm
Profondità di misurazione	125 mm
Dimensioni durometro	185 x 465 x 640 mm
Forza di misurazione	588,4 N / 980,7 / 1471 N (60 kgf / 100 kgf / 150 kgf)
<b>SCALE DI MISURAZIONE:</b>	
HRC	20 ÷ 70
HRB	25 ÷ 100
HRA	20 ÷ 88
Peso netto	90 kg

**D018**

€ 5110,00

**DUROMETRO DA BANCO**

Motorizzato, rockwell, brinell e vickers.



Cassa di legno

Forza di misurazione	294,2 N / 306,5 N / 588,4 N / 612,9 N / 980,7 N / 1471 N / 1839 N; 30 kgf / 31,25 kgf / 60 kgf / 62,5 kgf / 100 kgf / 150 kgf / 187,5 kgf
Penetratore in diamante a cono e piramide	n° 1+1
Penetratore a sfera	n° 3
Incudini piani	n° 2
Incudine a V	n° 1
Blocchetti di taratura	n° 2 Brinell; n° 2 Rockwell; n° 1 Vickers
Ingrandimenti	37,5x - 75x
Altezza max del pezzo da misurare	Rockwell: 175 mm; Brinell - Vickers: 145 mm

Profondità di misurazione	160 mm
Alimentazione	230 V - 50 / 60 Hz - 6 W
Dimensioni durometro	525 x 240 x 730h mm
<b>SCALE DI MISURAZIONE:</b>	
HBS	4 - 450
HRB	20 - 100
HRA	20 - 88
HRC	20 - 70
HV	200 - 1000
Peso netto	70 kg



**D007/A**
**€ 86,10**
**DUROMETRO SHORE "A"**

Misuratore di durezza per gomme morbide, pelle, feltro, cere.



Campo di misura	0 ÷ 100 A
Lettura	2 A

**D011/A**
**€ 150,00**
**DUROMETRO DIGITALE SHORE "A"**

Misuratore di durezza per gomme morbide, pelle, feltro, cere.



Campo di misura	0 ÷ 100 A
Lettura	0,5 A
Batteria	1 x 3 V CR2032

**D011/D**
**€ 150,00**
**DUROMETRO DIGITALE SHORE "D"**

Misuratore di durezza per gomme dure e materie plastiche.



Campo di misura	0 ÷ 100 D
Lettura	0,5 D
Batteria	1 x 3 V CR2032

**P013**
**€ 157,00**
**PROVINI IN GOMMA SHORE "A"**

Con durezza variabile da 26ha a 88ha. Provini di colore viola, marrone, verde, arancione, rosso, giallo e grigio. Precisione ±2ha.



7 Pcs

**S110**
**€ 431,00**
**SCLEROMETRO**

Per la misurazione di durezza dei manufatti in cemento.



Energia di percussione	2.207 Nm
Tensione molla	7.84 N
Corsa	75 mm

**S111**
**€ 476,00**
**INCUDINE PER TARATURA SCLEROMETRO**

**B031 € 25,40**
**BILANCINA DIGITALE DI PRECISIONE TASCABILE**

Non idoneo nei rapporti con terzi.



Scatola

Capacità	100 g
Letture	0,01 g
Tipo di pesatura	g / dwt / tl / ct
Batteria	1 x 3 V CR2032

**B021 € 20,60**
**BILANCINA DIGITALE DI PRECISIONE TASCABILE**

Non idoneo nei rapporti con terzi. Funzioni tara e calibrazione.



Scatola

Capacità	500 g
Letture	0,1 g
Tipo di pesatura	g / dwt / gn / ct
Batteria	2 x 1,5V AAA

**B003/5/1 € 36,90**
**BILANCIA ELETTRONICA DIGITALE**

Non idoneo nei rapporti con terzi, funzione tara, autospegnimento.



Scatola

Capacità	5 kg - 176,4 oz
Letture	1 g   0,1 oz
Batteria	2 x 1,5V AA
Dimensioni	170 x 240 x 35 mm

**B018 € 134,00**
**BILANCIA ELETTRONICA DIGITALE CON DOPPIO DISPLAY**

Non idoneo nei rapporti con terzi. Dotata di batteria 4 V 4 AH e caricabatteria. Memoria per valori unitari. Calcoli valori totali.



Scatola

Capacità	30 kg
Letture	10 g
Dimensione piatto	340 x 230 mm
Dimensioni	350 x 330 x 120 mm
Alimentazione	230V 50 Hz
Batteria ricaricabile	1 x 4 V 4 Ah

**B004- BILANCIA ELETTRONICA DIGITALE CONTAPEZZI RICARICABILE**

Non idoneo nei rapporti con terzi, Dotata di batteria 6V 4A e caricabatterie.

**0561/B € 38,50**
**BATTERIA DI RICAMBIO**

Per tutte le bilance B004.



Scatola

Art.	€	Capacità	Letture	Dimensioni bilancia da banco	Dimensioni piatto	Batteria ricaricabile
B004/7	€ 410,00	7,5 kg	0,2 g	350 x 340 x 105 mm	335 x 228 mm	1 x 6 V 4 Ah
B004/30	€ 410,00	30 kg	1 g	350 x 340 x 105 mm	335 x 228 mm	1 x 6 V 4 Ah





**B004/150**

€ 800,00

**BILANCIA ELETTRONICA DIGITALE CONTAPEZZI RICARICABILE**

Non idoneo nei rapporti con terzi, Dotata di batteria 6V 4A e caricabatterie.

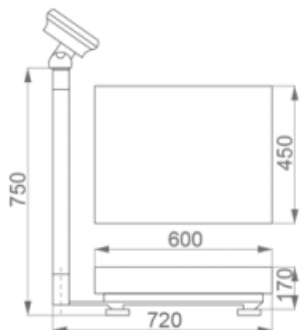

Scatola

Capacità	150 kg
Letture	10 g
Batteria ricaricabile	1 x 6 V 4 Ah
Peso netto	17 kg

**0561/B**

€ 38,50

**BATTERIA DI RICAMBIO**

Per tutte le bilance B004.



**D010-**

**DINAMOMETRI DIGITALI**

Con struttura in fusione di alluminio, dotati di batteria, caricabatterie, telecomando ad infrarossi e segnale sonoro. Doppia unità di misura kg / lb. Con funzioni di Picco, Hold, Tara, Zero e addizione. Caratteri grandi per una facile lettura. Non idoneo nei rapporti con terzi.



Scatola

Art.	€	Grandezza caratteri	Portata	Letture	Pesata minima	Carico limite	Batteria	Peso netto
D010/0100	€ 622,00	40 x 20 mm	1000 kg	0.500 kg	0.500 kg	150%	1 x 6 V 4 Ah	7,1 kg
D010/0300	€ 749,00	40 x 20 mm	3000 kg	1 kg	1 kg	150%	1 x 6 V 4 Ah	7,5 kg
D010/0500	€ 876,00	40 x 20 mm	5000 kg	2 kg	2 kg	150%	1 x 6 V 4 Ah	12,3 kg
D010/1000	€ 1100,00	40 x 20 mm	10000 kg	5 kg	5 kg	150%	1 x 6 V 4 Ah	25,7 kg

**D012-**

**DINAMOMETRI DIGITALI**

Dotati di batteria, caricabatterie, radiocomando, retroilluminazione e segnale sonoro. Doppia unità di misura kg/lb. Con funzioni di Picco, Hold, Tara e Zero. Caratteri grandi per una facile lettura. Non idoneo nei rapporti con terzi.



Scatola

Art.	€	Grandezza caratteri	Portata	Letture	Pesata minima	Carico limite	Batteria ricaricabile	Peso netto
D012/0100	€ 938,00	40 x 20 mm	1001 kg	0,200 kg	0,200 kg	150%	1 x 6 V 10 Ah	12 kg
D012/0300	€ 1110,00	40 x 20 mm	3001 kg	0,500 kg	0,500 kg	150%	1 x 6 V 10 Ah	14,5 kg
D012/0500	€ 1280,00	40 x 20 mm	5001 kg	1 kg	1 kg	150%	1 x 6 V 10 Ah	19 kg
D012/1000	€ 1530,00	40 x 20 mm	10001 kg	2 kg	2 kg	150%	1 x 6 V 10 Ah	32 kg