

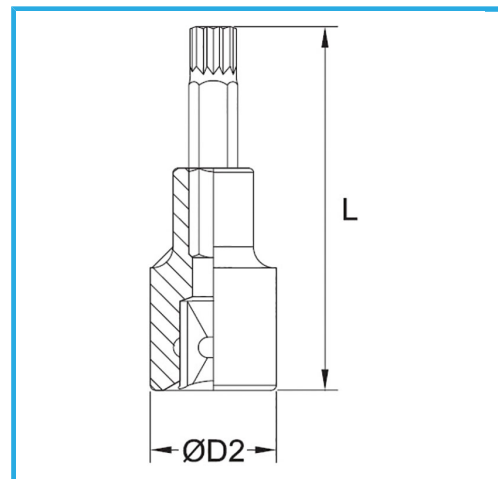

€10,20



Misura	M 12
D2	22 mm
Lunghezza	55 mm
Dimensioni imballo	40 x 115 x 22 h mm
Peso lordo	0,09 kg
Codice EAN	8012667282752



Append.



-



Cr-V

-



Cromata



1/2"