

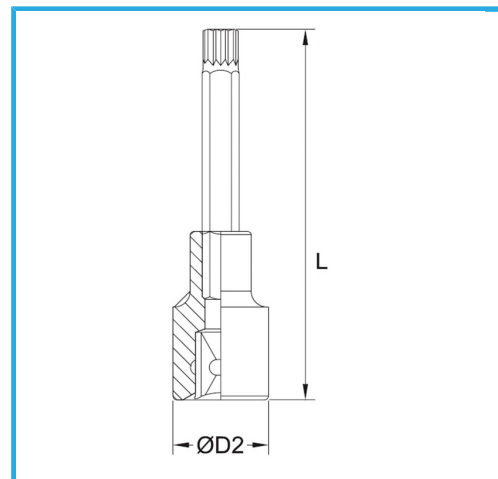

€10,80



Misura	M 9
D2	22 mm
Lunghezza	100 mm
Dimensioni imballo	-
Peso lordo	0,10 kg
Codice EAN	8012667282813



Append.



-



Cr-V

-



Cromata



1/2"