

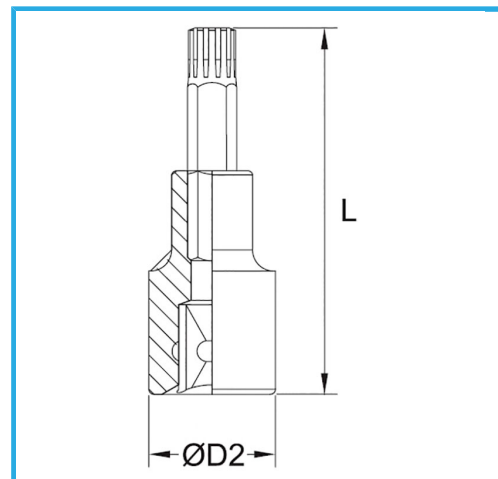

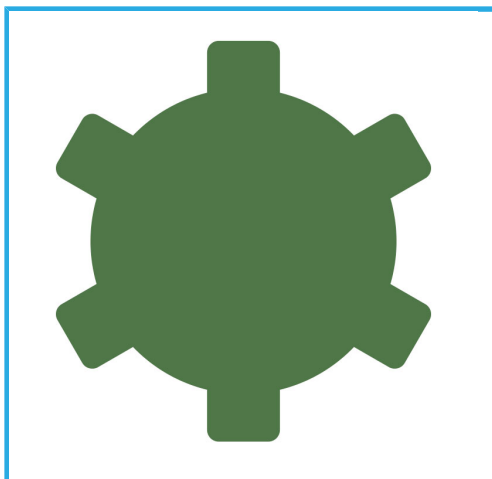





€9,50



Misura	M 12
D2	22 mm
Lunghezza	55 mm
Dimensioni imballo	-
Peso lordo	0,11 kg
Codice EAN	8012667282615

	Append.		-
	-		Cromata
	1/2"		