

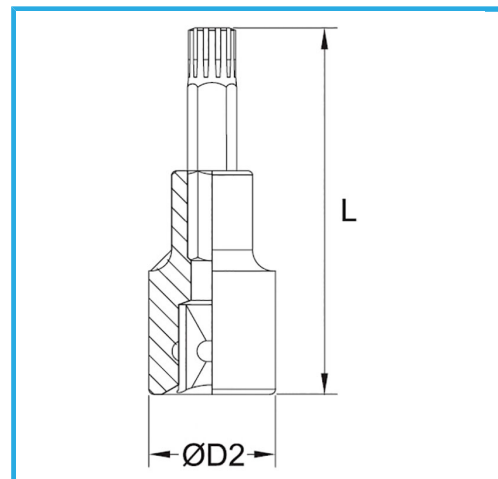

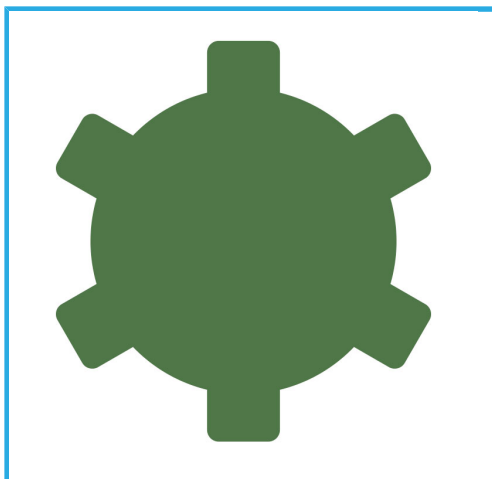





€8,60



Misura	M 10
D2	22 mm
Lunghezza	55 mm
Dimensioni imballo	-
Peso lordo	0,08 kg
Codice EAN	8012667282608

	Append.		-
	-		Cromata
	1/2"		