

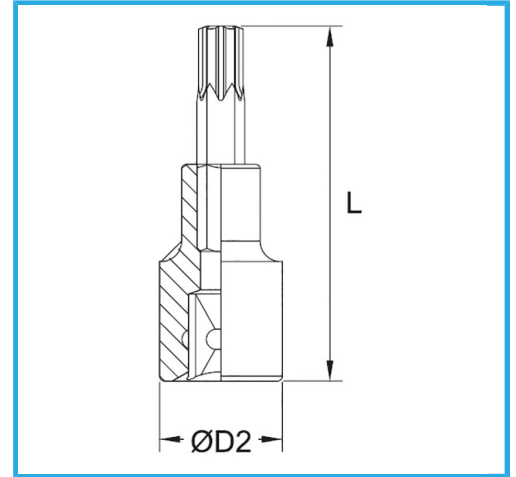







€6,80



Medida	T45
D2	18 mm
Longitud	48 mm
Dimensiones de embalaje	45 x 130 x 30 h mm
Peso bruto	0,05 kg
Codigo de barras	8012667281786

	Colgante		-
	-		Cromado
	3/8"		