

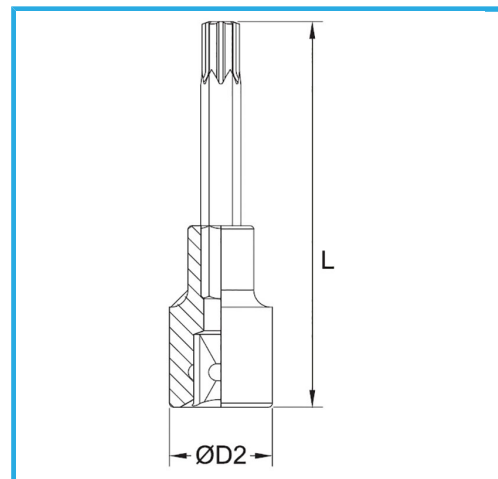

€9,00



Misura	T25
D2	22 mm
Lunghezza	100 mm
Peso lordo	0,10 kg
Dimensioni imballo	40 x 160 x 22 h mm
Codice EAN	8012667282493



Append.



-



Cr-V

-



Cromata



1/2"