

SCHNELLVERSTELLUNG, LAUFFLÄCHEN HOCHPRÄZISE GESCHLIFFEN.
GENAUIGKEIT ANGEGBEN AUF PARALLELITÄT UND...

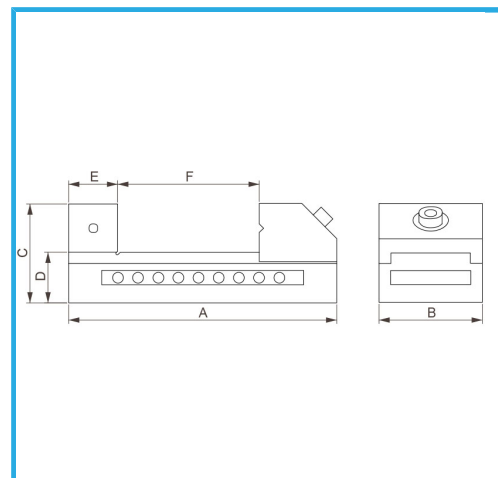

Abmessungen	50 x 140 x 50h mm
Öffnung	65 mm g
Backenhöhe	25 mm
Präzision	0,005 mm
Verpackungsmaße	175x90x65 h mm
Bruttogewicht	1,78 kg
EAN-Code	8012667268824

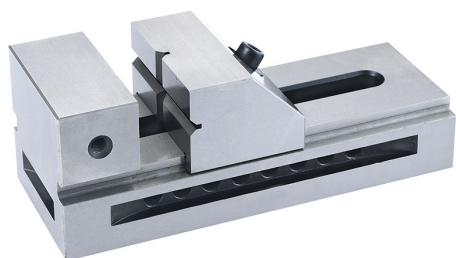

Holzkasten



Gehärteter



Stahl



Gehärtet