

SUITABLE FOR THREAD REGENERATION OR TO OBTAIN VERY RESISTANT TAPPING IN SOFT MATERIALS.

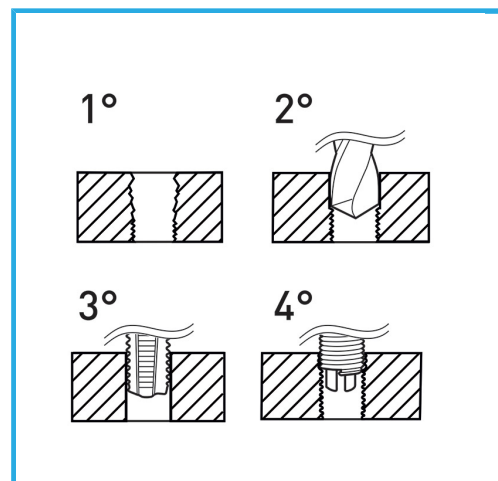

Thread insert	M12
Drill	12,4 mm
Tap	x M12
Handle	2
Gross weight	0,69 kg
Packaging dimensions	160x120x34 h mm
EAN Code	8012667249977



Hangable

HSS

INOX