

SUITABLE FOR THREAD REGENERATION OR TO OBTAIN VERY RESISTANT TAPPING IN SOFT MATERIALS.

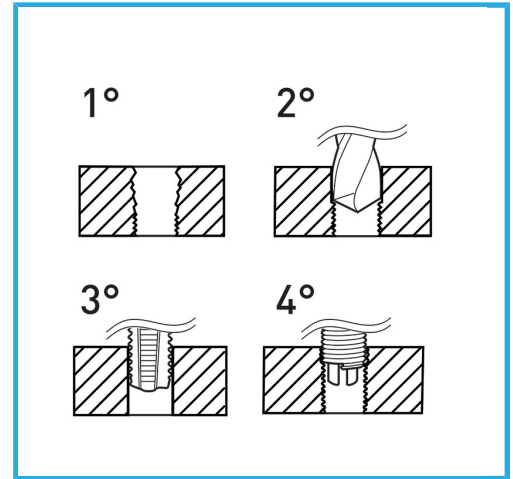

Thread insert	M6
Drill	6,3 mm
Tap	x M6
Handle	2
Gross weight	0,42 kg
Packaging dimensions	160x115x35 h mm
EAN Code	8012667249946



Hangable

HSS



INOX