

ART. M001/03V
MACHINE TAPS STRAIGHT FLUTE, SPIRAL POINTED FOR THROUGH HOLES

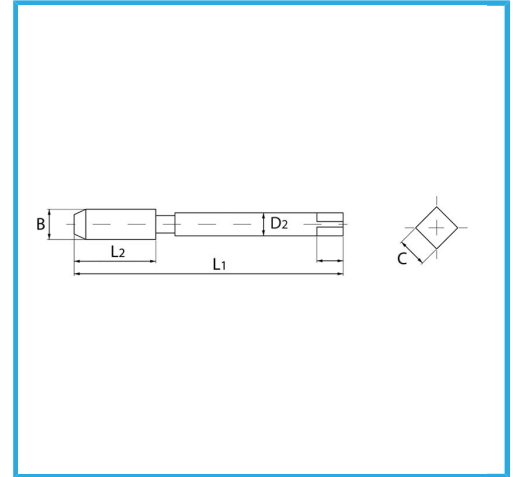

ISOMETRIC THREAD COARSE PITCH - REINFORCED SHANK, THE VAPORIZATION TREATMENT INCREASES THE SURFACE HARDNESS AND WEAR RESISTANCE...

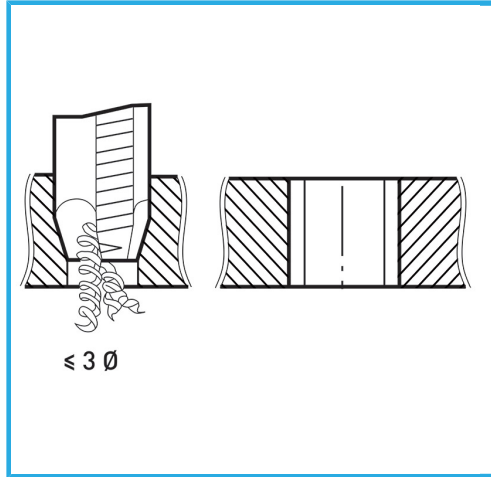

B	M3 x 0,50 mm
L2	11 mm
L1	56 mm
D2	3.5 mm
C	2.7 mm
Gross weight	0,00 kg
Packaging dimensions	65x11x11h mm
EAN Code	8012667257347



Box



HSS-G



Vaporized



HV=750



External



371/B