

ISO 2

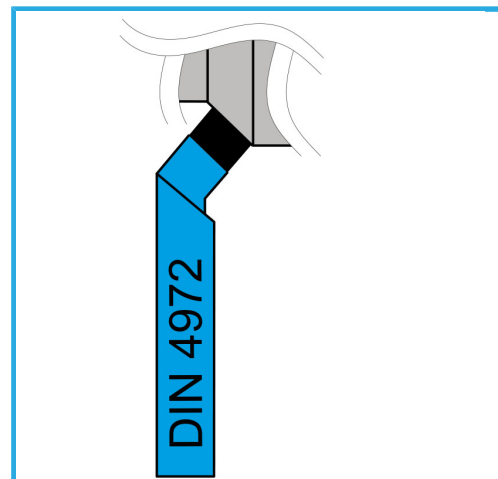

€15,40

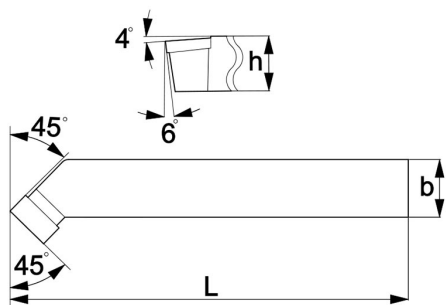

L	140 mm
b	25 mm
h	25 mm
Peso lordo	0,63 kg
Dimensioni imballo	230x50x40 h mm
Codice EAN	8012667007515

HM
P25



4972