

ISO 2

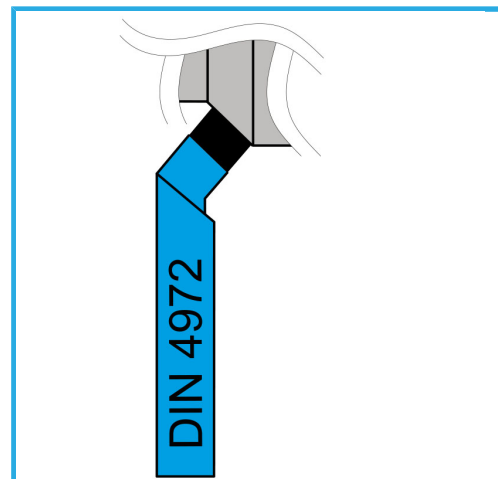

L	110 mm
b	16 mm
h	16 mm
Bruttogewicht	0,20 kg
Verpackungsmaße	125x40x20 h mm
EAN-Code	8012667007492

HM
P25

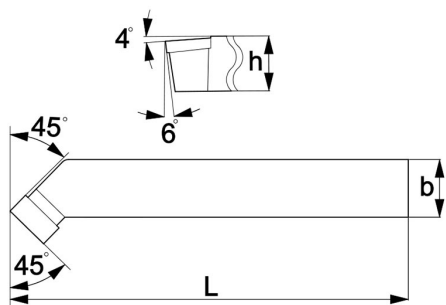

4972