

ISO 2

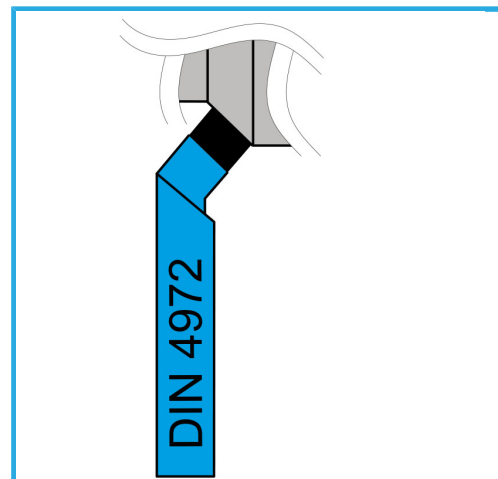

€7,20

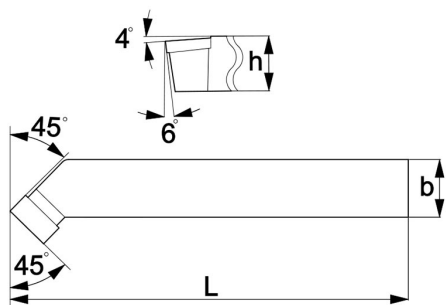

L	100 mm
b	12 mm
h	12 mm
Peso lordo	0,11 kg
Dimensioni imballo	100x12x12 h mm
Codice EAN	8012667008826

HM
P25



4972