

ISO 6

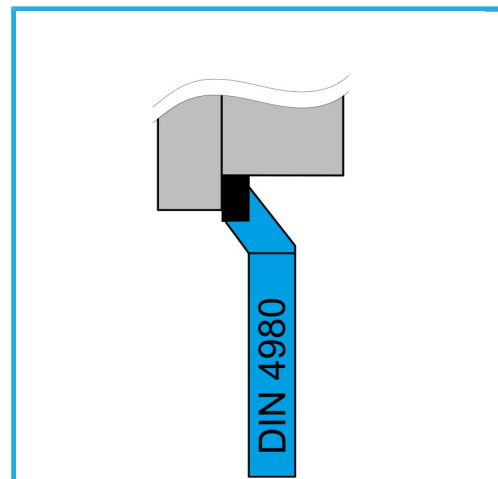

€14,70

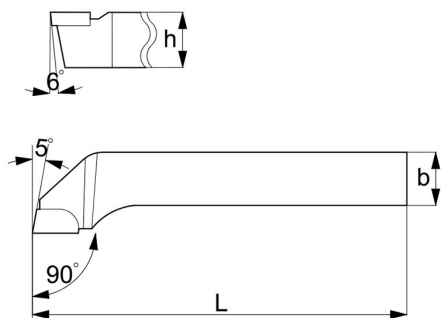

L	140 mm
b	25 mm
h	25 mm
Peso lordo	0,64 kg
Dimensioni imballo	140x25x25 h mm
Codice EAN	8012667007461

HM
P25



4980