

ISO 6

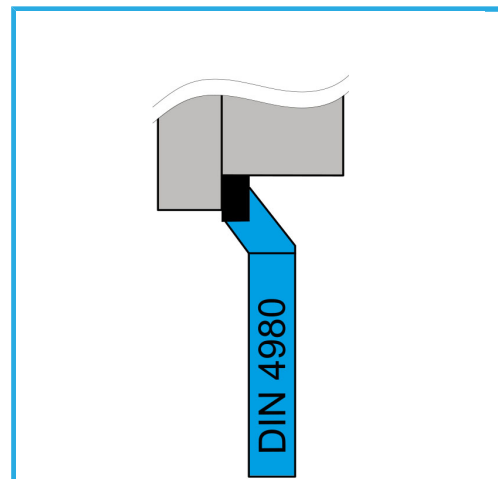

€10,10

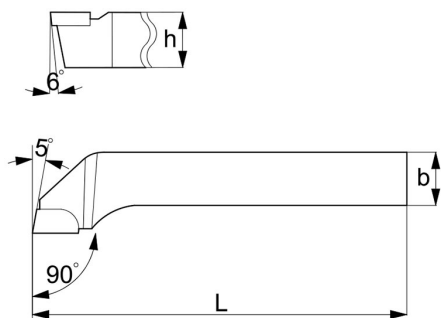

L	125 mm
b	20 mm
h	20 mm
Peso lordo	0,36 kg
Dimensioni imballo	125x20x20 h mm
Codice EAN	8012667007454

HM
P25



4980