

ISO 6

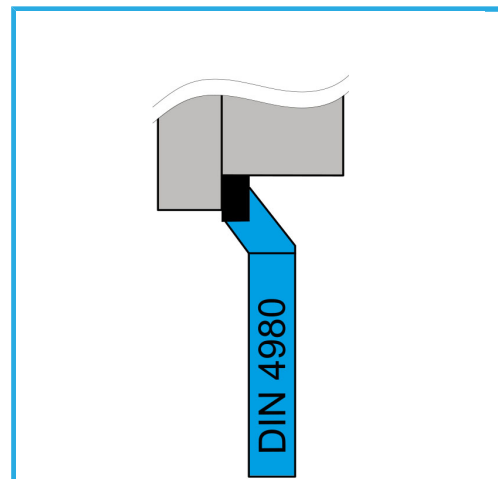

€6,90

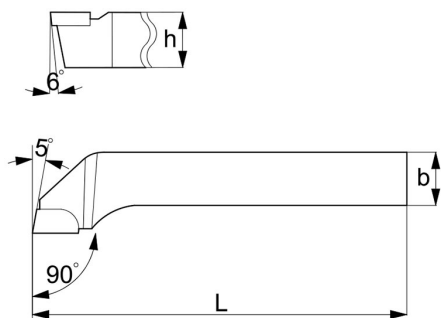

L	100 mm
b	12 mm
h	12 mm
Peso lordo	0,11 kg
Dimensioni imballo	100 x 20 x 20 h mm
Codice EAN	8012667008673

HM
P25



4980