

CON CONEXIÓN DE MANGUITO, RECOMENDADO PARA USO EN MÁQUINAS CON POTENCIA MEDIA.

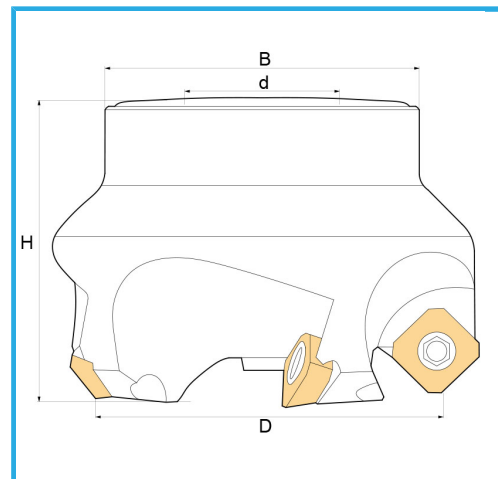

€190,00

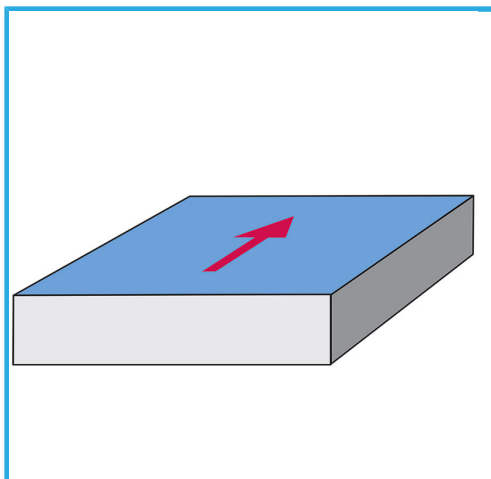

D	80 mm
H	50 mm
B	93 mm
d	27 mm
Z	5
Tornillos	KV500
Paquita (no incluida)	SEHX1204... / SEHT1204...
Peso bruto	1,07 kg
Dimensiones de embalaje	120x120x75 h mm
Codigo de barras	8012667182571



Caja



Satinado



Niquelada



Externa