

MIT MUFFENANSCHLUSS, EMPFOHLEN FÜR DEN EINSATZ AN MASCHINEN MIT MITTLERER LEISTUNG.

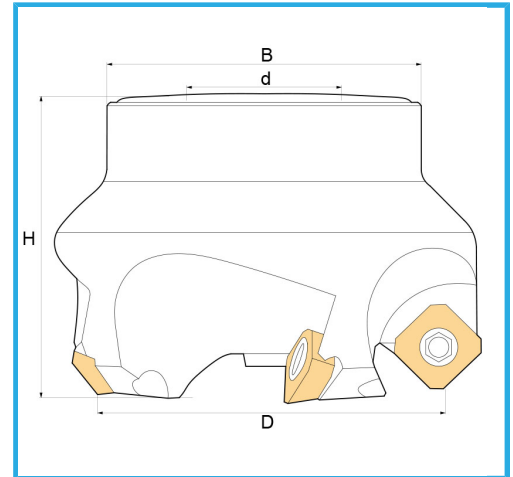

D	50 mm
H	48 mm
B	60 mm
d	22 mm
Z	4
Schrauben	KV500
Einsatz (nicht im Lieferumfang enthalten)	SEHX1204... / SEHT1204...
Bruttogewicht	0,67 kg
Verpackungsmaße	98x70x70 h mm
EAN-Code	8012667183936

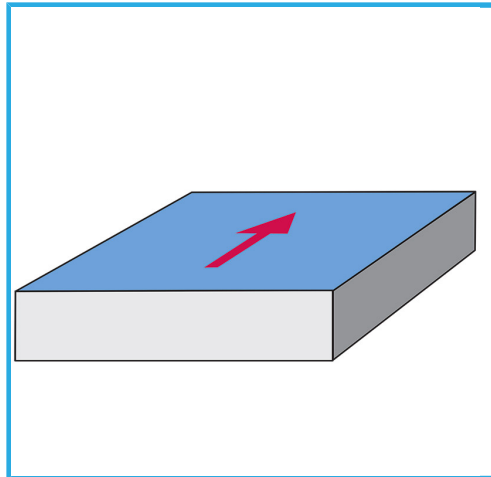

Box



Satiniert



Vernickelt



Extern