

WITH SLEEVE CONNECTION, RECOMMENDED FOR USE ON MACHINES WITH MEDIUM POWER.

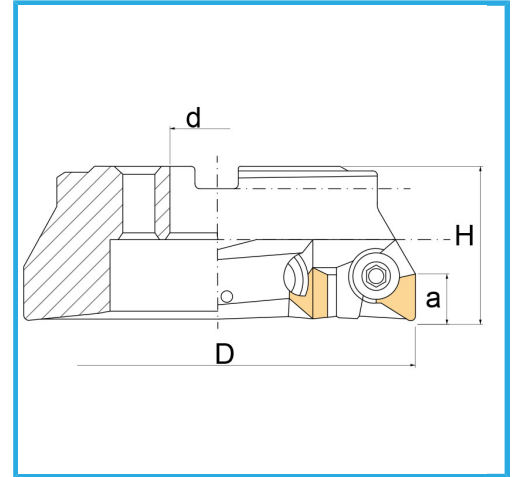

D	40 mm
H	40 mm
a	16 mm
d	16 mm
Z	3
Screw	F256/644
Insert (not included)	TPKN1603...
Gross weight	0,27 kg
Packaging dimensions	60x60x80 h mm
EAN Code	8012667189860

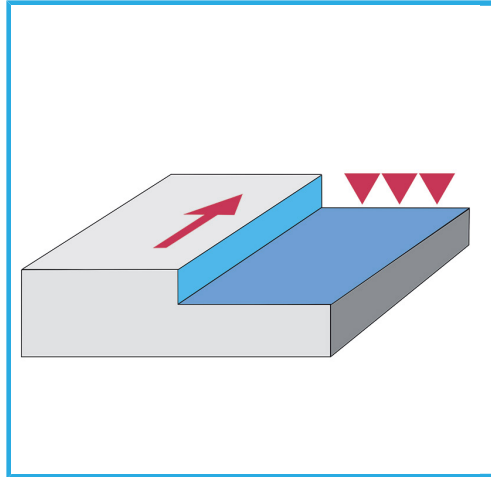

Box



Satin



Nickel
plated



Internal