

€60,60

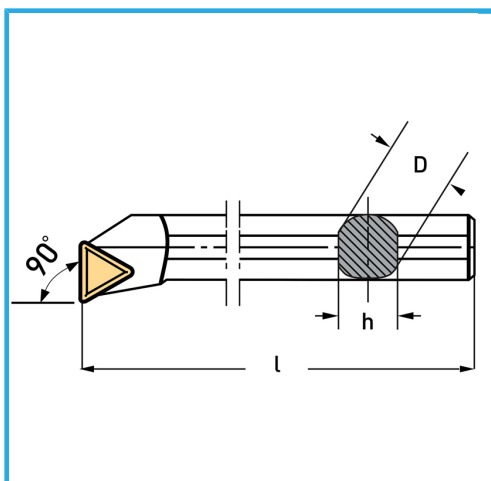

Lato	Dx/R
D	10 mm
h	9 mm
l	150 mm
Vite	KV250
Inserto (non incluso)	TCMT1102...
Peso lordo	0,11 kg
Dimensioni imballo	155x25x25 h mm
Codice EAN	8012667009298



Scatola



Satinata



Nichelata



Esterna