

€60,60

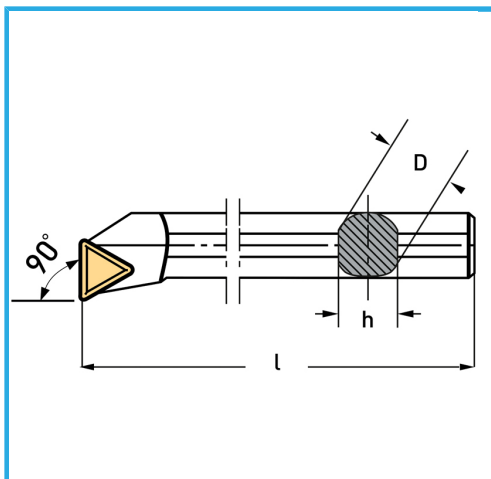

Lado	Dx/R
D	8 mm
h	7 mm
l	125 mm
Tornillo	KV250
Paqueta (no incluida)	TCMT1102...
Peso bruto	0,06 kg
Dimensiones de embalaje	130x25x25 h mm
Codigo de barras	8012667009274



Caja



Satinado



Niquelada



Externa