

INSERTI INCLUSI, UTILE PER AVERE UN SET CHE PERMETTE DI ESEGUIRE LA MAGGIOR PARTE DI OPERAZIONI DI TORNITURA CON TORNII DI...



€117,00
~~€148,00~~



UPGRADE

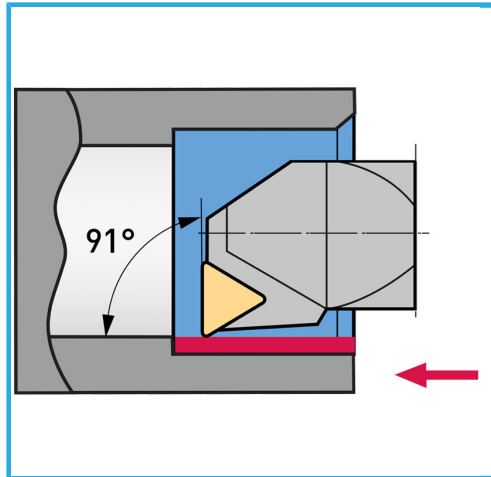

Stelo ut. est. / Inserto

16 mm / TCMT16T304...

Stelo ut. int. / Inserto

12 mm / TCMT110204...

Lunghezza

Ext: 100 mm / Int: 150 mm

Vite

Ext: KV400 / Int: KV250

Peso lordo

1,17 kg

Dimensioni imballo

185x170x45 h mm

Codice EAN

8012667243975



Scatola



Brunita



Esterna