

ER32 DIN 6499/B UTILIZZABILE CON MANDRINI PORTAPINZE.

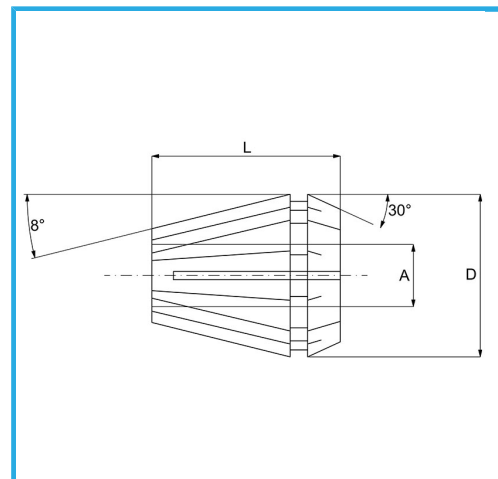

€15,70



Capacità A	15-16 mm
D	33 mm
L	40 mm
Peso lordo	0,20 kg
Dimensioni imballo	40x40x45 h mm
Codice EAN	8012667142032



Scatola



Rettificato

65Mn