

DIN 228/A, ZUR AUFNAHME VON WERKZEUGEN MIT ZYLINDERSCHAFT AUF DIN 6499 (ER) SPANNZANGEN. LIEFERUNG MIT SICHERUNGSRING.

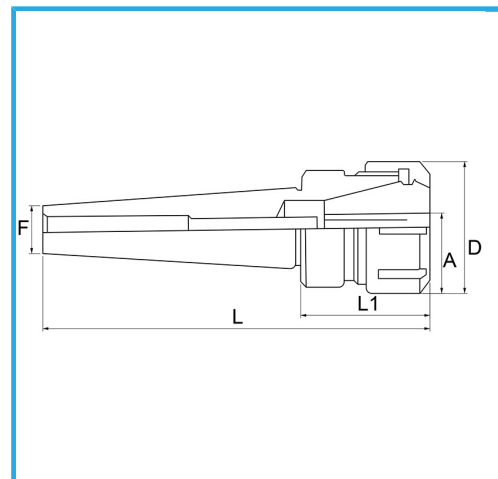

Spannzange	ER 32
D	50 mm
L	135 mm
L1	60 mm
F	M 10
A	3 / 20 mm
Bruttogewicht	0,49 kg
Verpackungsmaße	60x60x145 h mm
EAN-Code	8012667140151



Box

18Ni
CrMo5



Gehärtet