

DIN 2080, BALANCED CHUCK BODY, FOR MILLING CUTTERS (WELDON)
ACCORDING TO DIN 1835 B AND DIN 6535 HB. SUPPLIED WITH
TIGHTENING...

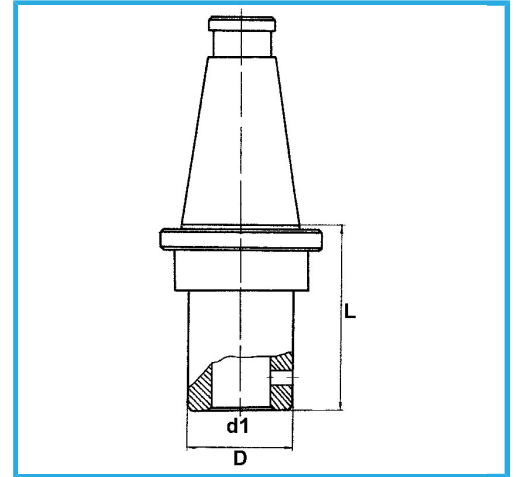

ISO	50
d1 - h6	32 mm
D	72 mm
L	80 mm
Gross weight	4,16 kg
EAN Code	8012667187606



Box



Grounded



18Ni
CrMo5

-