

DIN 2080, BALANCED CHUCK BODY, FOR MILLING CUTTERS (WELDON)
ACCORDING TO DIN 1835 B AND DIN 6535 HB. SUPPLIED WITH
TIGHTENING...

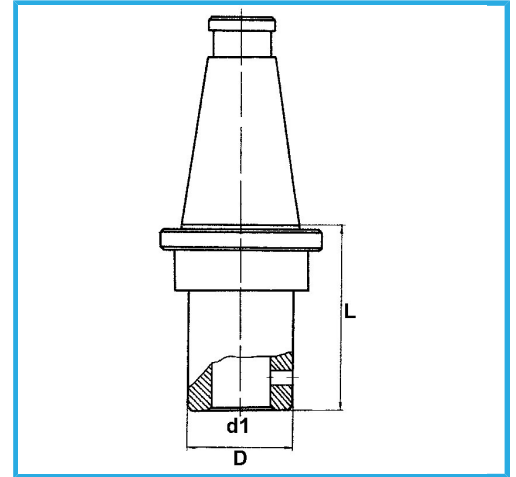

ISO	40
d1 - h6	10 mm
D	35 mm
L	50 mm
Gross weight	1,02 kg
EAN Code	8012667195892



Box



Grounded



18Ni
CrMo5

-