

MAS-403 BT, BALANCED CHUCK BODY, FOR CYLINDRICAL END MILLS ACCORDING TO DIN 481, FOR MILLING CUTTERS WITH LONGITUDINAL GROOVE...

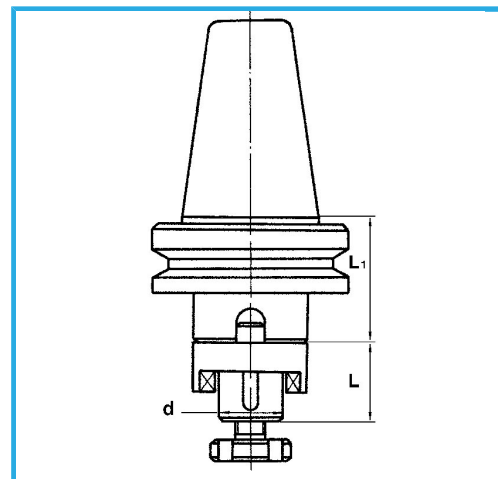

BT	50
d - h6	32 mm
L	38 mm
L1	40 mm
Gross weight	4,76 kg
Packaging dimensions	-
EAN Code	8012667008604



Box



Tempered



Grounded



18Ni
CrMo5

-