

MAS-403 BT, CORPO MANDRINO BILANCIATO, PER FRESE (WELDON)
SECONDO NORMA DIN 1835 B E DIN 6535 HB. FORNITO CON VITE DI
SERRAGGIO...

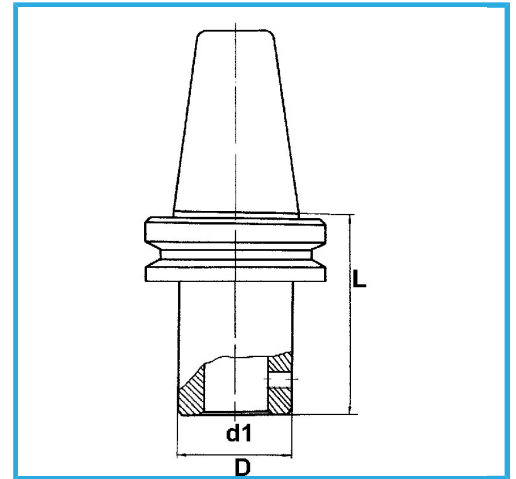

€154,00



BT	50
d1 - h6	40 mm
D	80 mm
L	120 mm
Peso lordo	6,66 kg
Codice EAN	8012667195458



Scatola



Rettificato



18Ni
CrMo5