

MAS-403 BT, CORPO MANDRINO BILANCIATO, PER FRESE (WELDON)  
SECONDO NORMA DIN 1835 B E DIN 6535 HB. FORNITO CON VITE DI  
SERRAGGIO...

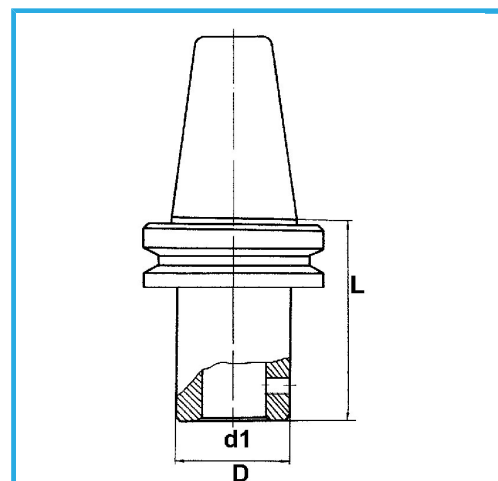

€138,00



BT	50
d1 - h6	12 mm
D	42 mm
L	75 mm
Peso lordo	3,96 kg
Codice EAN	8012667193140



Scatola



Rettificato

18Ni  
CrMo5