

MAS-403 BT, CORPO MANDRINO BILANCIATO, CON ASOLA DI ESTRAZIONE PER UTENSILI. EQUILIBRATURA 12.000 RPM.

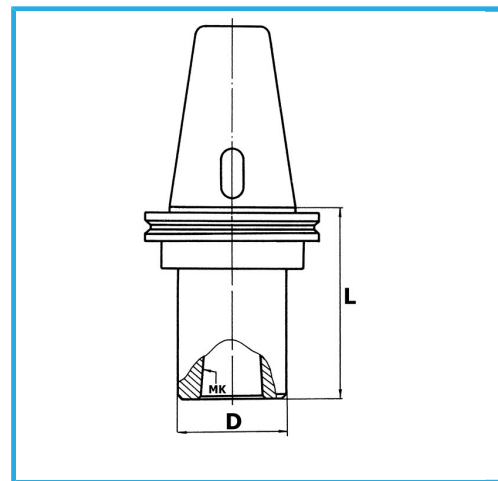

€149,00



BT	40
CM	1
D	25 mm
L	45 mm
Peso lordo	1,10 kg
Codice EAN	8012667008376



Scatola



Rettificato

18Ni
CrMo5