

DIN 69871/A, CORPO MANDRINO BILANCIATO. EQUILIBRATURA 12.000 RPM.

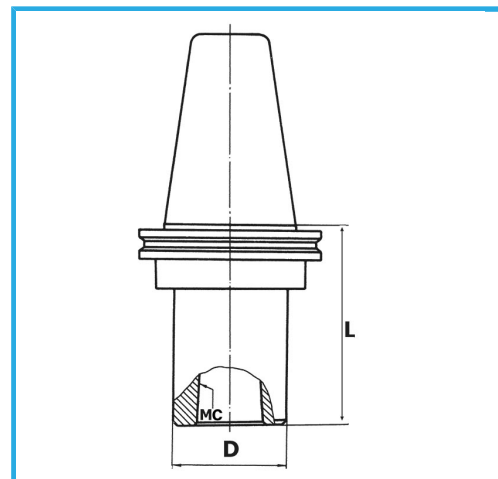

€165,00



ISO	50
CM	3
D	40 mm
L	50 mm
Peso lordo	3,12 kg
Codice EAN	8012667008000



Scatola



Rettificato

18Ni
CrMo5