

DIN 69871/A, CORPO MANDRINO BILANCIATO. EQUILIBRATURA 12.000 RPM.

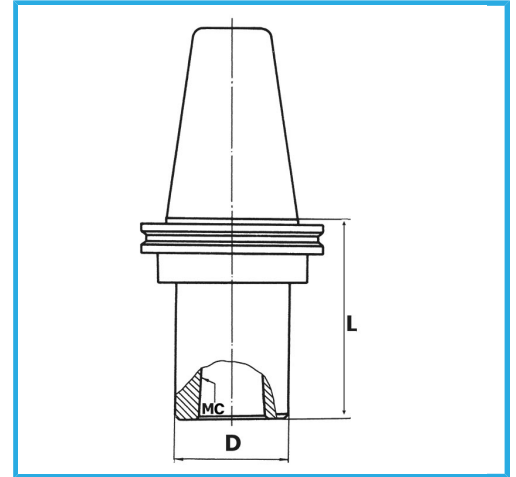

€165,00



ISO	50
CM	2
D	32 mm
L	40 mm
Peso lordo	2,77 kg
Codice EAN	8012667007997



Scatola



Rettificato

18Ni
CrMo5