

DIN 69871/A, AUSGEWUCHTETES SPANNFUTTERGEHÄUSE, FÜR
FRÄSER (WELDON) NACH DIN 1835 B UND DIN 6535 HB. LIEFERUNG...

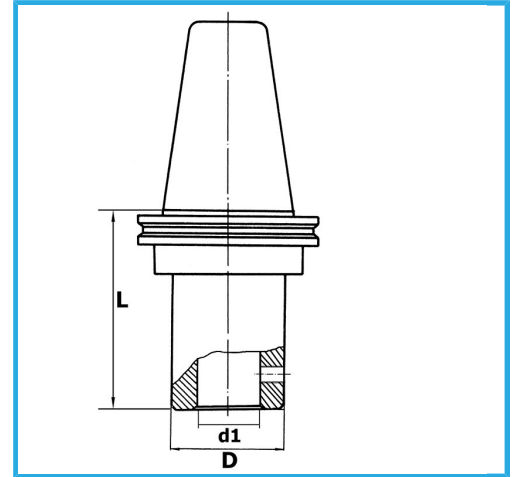

ISO	50
d1 - h6	25 mm
D	65 mm
L	100 mm
Bruttogewicht	3,87 kg
EAN-Code	8012667193218



Box



Gehärtet



18Ni
CrMo5

-