

DIN 69871/A, CORPO MANDRINO BILANCIATO, PER FRESE (WELDON)
SECONDO NORMA DIN 1835 B E DIN 6535 HB. FORNITO CON VITE DI...

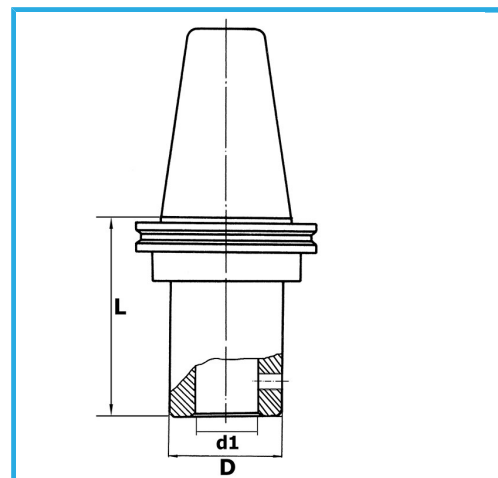

€96,50



ISO	40
d1 - h6	12 mm
D	42 mm
L	60 mm
Peso lordo	1,24 kg
Codice EAN	8012667195519



Scatola



Rettificato

18Ni
CrMo5