

SPANNFUTTER NICHT IM LIEFERUMFANG ENTHALTEN,
 AUSGESTATTET MIT GEHÄRTETER UND GESCHLIFFENER SCHNECKE
 UND...

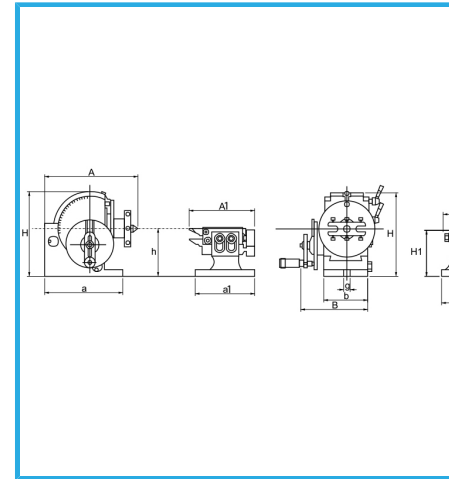

A	193 mm
B	131 mm
H	173 mm
h	100 mm
a	166 mm
b	90 mm
G	16 mm
A1	175 mm
B1	87 mm
H1	102 mm
h1	100 mm
a1	130 mm
b1	82 mm
geeignetes Spannfutter	Ø 125 mm
g1	16 mm
Bohrung	ø 18 mm g
CM	2
Übersetzungsverhältnis	1:40
Kopfneigung links und rechts	-10° - 90°
Löcher in Scheiben	15-16-17-18-19-20-21-23-27-29-31-33-37-39-41-43-47-49
Nettogewicht	16 kg
Verpackungsmaße	420x250x250 h mm
Bruttogewicht	18,47 kg
EAN-Code	8012667188092



Box