

DOTATA DI REGOLAZIONE MICROMETRICA ED INGRANAGGI A BAGNO D'OLIO.

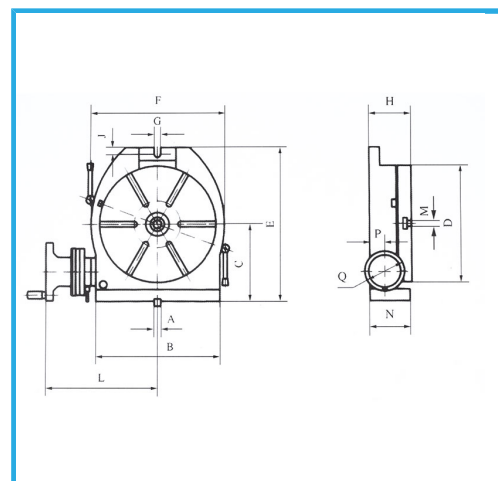

€844,00

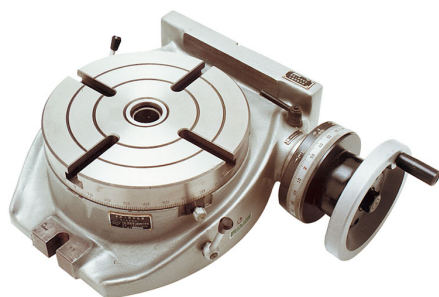

A	12 mm
B	186 mm
C	125 mm
D	160 mm
E	242 mm
F	196 mm
G	12 mm
H	85 mm
J	12 mm
L	194 mm
N	82 mm
P	37 mm
Q	125 mm
CM	2
Rapporto	1:90
Cave	4/10 N° / mm
Portata max orizzontale	100 kg
Portata max verticale	50 kg
Peso netto	23 kg
Dimensioni imballo	430x430x220 h mm
Peso lordo	31,00 kg
Codice EAN	8012667180287



Cassa di legno