

EQUIPPED WITH MICROMETRIC ADJUSTMENT AND OIL BATH GEARS.

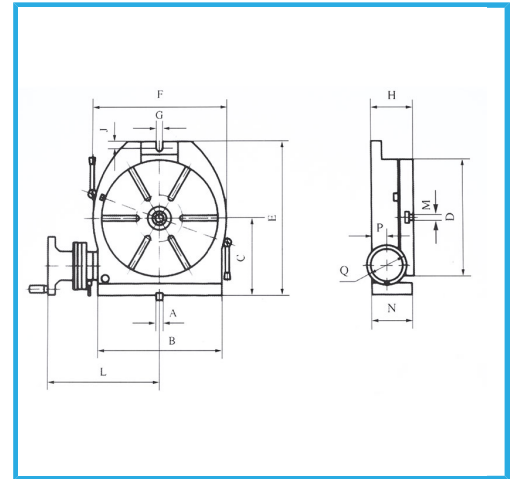

A	12 mm
B	186 mm
C	125 mm
D	160 mm
E	242 mm
F	196 mm
G	12 mm
H	85 mm
J	12 mm
L	194 mm
N	82 mm
P	37 mm
Q	125 mm
MT	2
Ratio	1:90
Slots	4/10 N° / mm
Hor. max load	100 kg
Ver. max load	50 kg
Net weight	23 kg
Packaging dimensions	430x430x220 h mm
Gross weight	31,00 kg
EAN Code	8012667180287

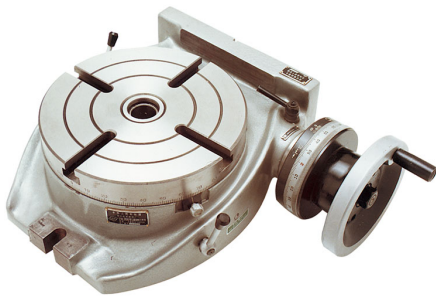

Wooden Box