

CON DENTATURA DI ATTACCO TEMPRATA E RETTIFICATA. AGENDO SU
DI UN PERNO ECCENTRICO, IL PORTAUTENSILE VIENE BLOCCATO
SULLA...

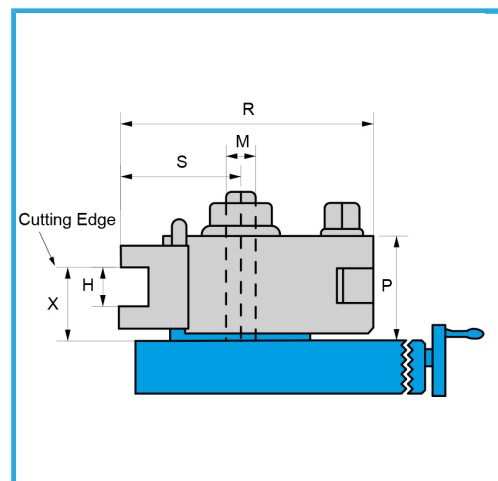

€1.790,00



R max	202 mm
S max	105 mm
P	102 mm
h	32 mm
X min	47 mm
Peso lordo	24,67 kg
Dimensioni imballo	330x260x225 h mm
Codice EAN	8012667191122



Scatola