

ADATTE PER LAVORI DOVE SONO RICHIESTI PRECISIONE,
AFFIDABILITÀ, REPERIBILITÀ E BLOCCAGGIO SICURO. INDICATA PER
LAVORI...

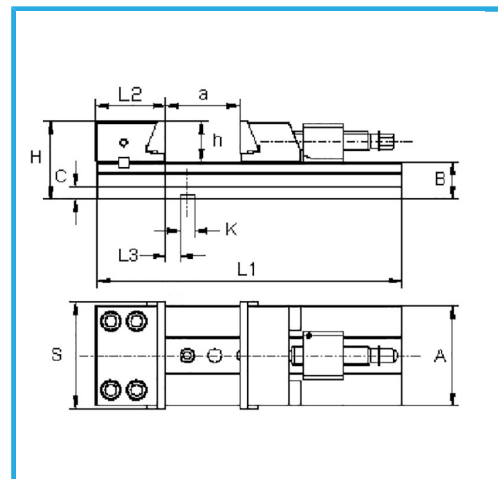

€1.620,00
~~€2.080,00~~

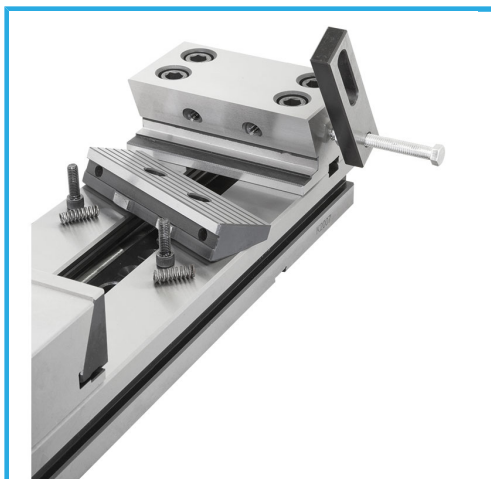
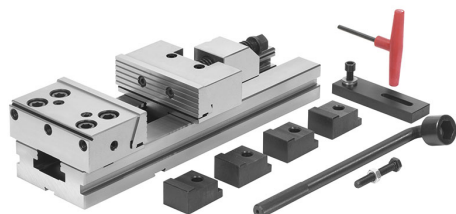

Dimensioni ganascia	200 x 65h mm
S	200 mm
A	170 mm
B	70 mm
C	26 mm
H	135 mm
L1	595 mm
L2	113,4 mm
L3	25,6 mm
h	65 mm
K h7	16 mm
a	300 mm
Peso netto	69 kg
Dimensioni imballo	650x250x220 h mm
Peso lordo	80,00 kg
Codice EAN	8012667254049



Cassa di
legno



Temprato



Rettificato



Acciaio