

SUITABLE FOR JOBS WHERE PRECISION, RELIABILITY, AVAILABILITY AND SECURE LOCKING ARE REQUIRED. SUITABLE FOR PRECISION MILLING AND..

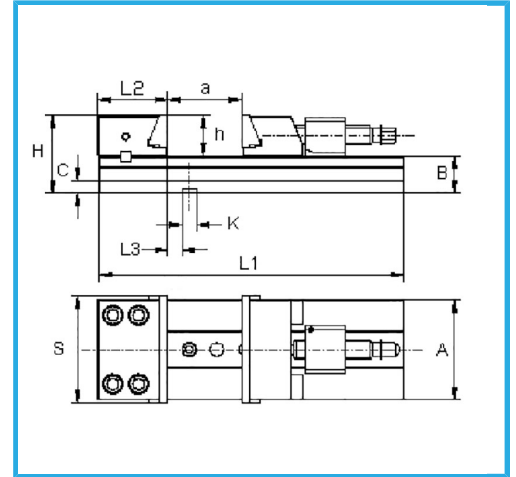

Jaw dimensions	150 x 50h mm
S	150 mm
A	125 mm
B	50 mm
C	20 mm
H	100 mm
L1	620 mm
L2	89,4 mm
L3	25,6 mm
h	50 mm
K h7	16 mm
a	400 mm
Net weight	34 kg
Packaging dimensions	670x200x180 h mm
Gross weight	39,00 kg
EAN Code	8012667253967

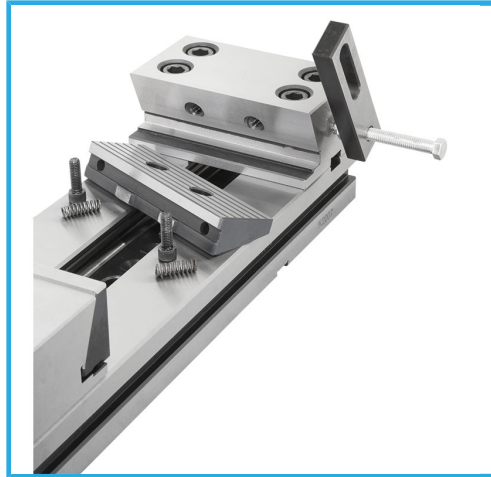
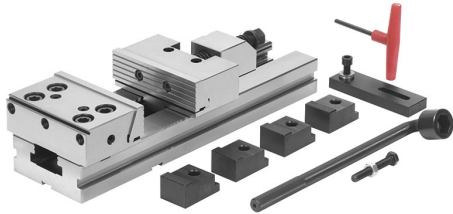

Wooden Box



Tempered



Grounded



Steel