

ADECUADO PARA TRABAJOS DONDE SE REQUIERE PRECISI3N, CON FIABILIDAD, DISPONIBILIDAD Y BLOQUEO SEGURO. ADECUADO PARA TRABAJOS..

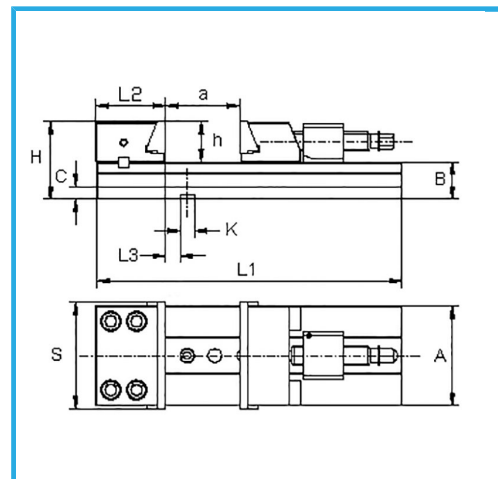

€1.340,00

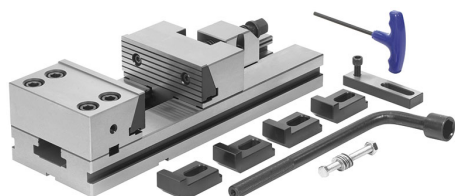

<b>Dimensiones mordaza</b>	150 x 60h mm
<b>Alcance m3n./m3x.</b>	150 mm
<b>A</b>	150 mm
<b>B</b>	50 mm
<b>C</b>	20 mm
<b>H</b>	110 mm
<b>L1</b>	435 mm
<b>L2</b>	93 mm
<b>L3</b>	25,6 mm
<b>h</b>	60 mm
<b>K h7</b>	16 mm
<b>a</b>	210 mm
<b>Peso neto</b>	35 kg
<b>Dimensiones de embalaje</b>	485x210x160 h mm
<b>Peso bruto</b>	35,99 kg
<b>Codigo de barras</b>	8012667191412



Caja de madera



Templado



Acero



Rectificado