

DIN 2080, CON CUERPO EQUILIBRADO, CON RANURA DE EXTRACCIÓN PARA HERRAMIENTAS. EQUILIBRADO 12.000 RPM.

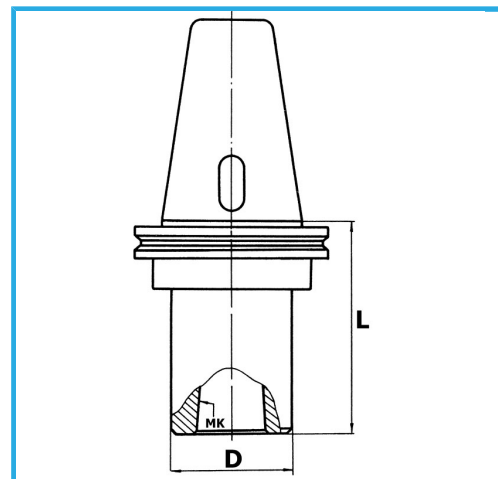

€100,00



ISO	40
CM	3
D	40 mm
L	65 mm
Peso bruto	0,97 kg
Codigo de barras	8012667407162



Caja



Rectificado