

PLAQUITAS INCLUIDAS, ÚTIL PARA TENER UN CONJUNTO QUE LE PERMITE REALIZAR LA MAYORÍA DE OPERACIONES DE TORNEADO CON...

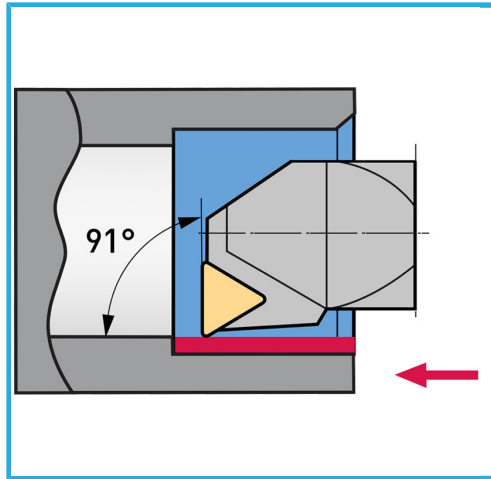

€199,00

UPGRADE



Vástago herr. ext. / inserto

20 mm / TCMT16T304...

Vástago herr. int. / inserto

16 mm / TCMT110204...

Longitud

Ext: 115 mm / Int: 200 mm

Tornillo

Ext: KV400 / Int: KV250

Peso bruto

2,05 kg

Dimensiones de embalaje

260x190x50 h mm

Codigo de barras

8012667408008



Caja



Bruñido



Externa