

OPTIMALER BETRIEB AN SENKRECHTEN WÄNDEN, DEN KERN NICHT ENTFERNEN, DER ALS MESSKAPPE FÜR DAS KÜHLMITTEL DIENT....

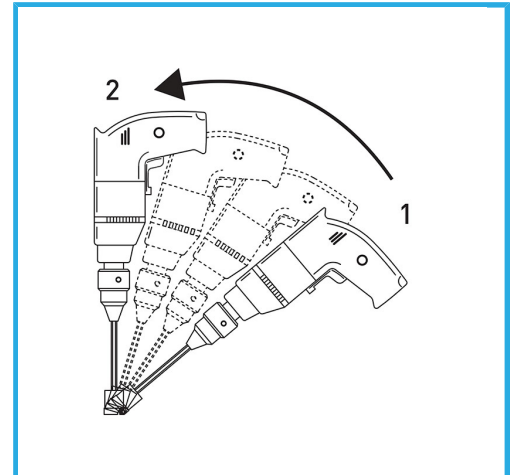

<b>Maß</b>	Ø 10 mm
<b>Sechskantkupplung</b>	9.5 mm g
<b>Gesamtlänge</b>	80 mm
<b>Diamanthöhe</b>	10 mm
<b>Stift</b>	40
<b>Verpackungsmaße</b>	115 x 32 x 32 h mm
<b>Bruttogewicht</b>	0,03 kg
<b>EAN-Code</b>	8012667355845

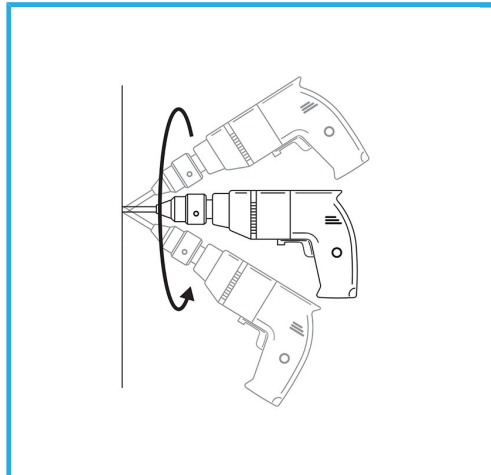

Aufhängbar