

ADATTI PER LA RIGENERAZIONE DELLE FILETTATURE O PER OTTENERE DELLE MASCHIATURE MOLTO RESISTENTI IN MATERIALI TENERI.

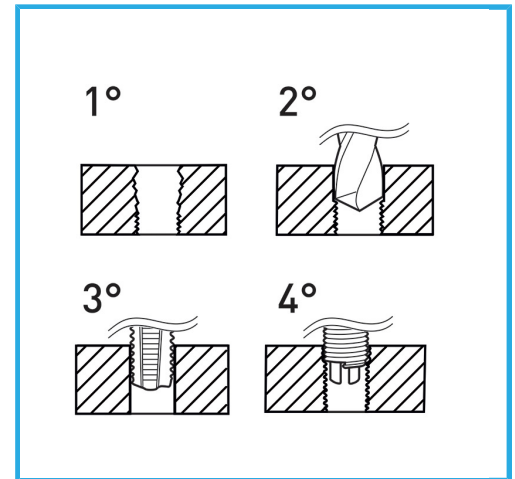

€35,90



Filetto	1/8" x 40
Punta	Ø 3.4 mm
Maschi STI	E011/BSW1/8M
Utensile montaggio	E011/U04
Attrezzo rottura	E011/A4
Inserti filettati	E010/BSW1/8E15
Quantità inserti	20
Dimensioni imballo	170x130x40 h mm
Peso lordo	0,35 kg
Codice EAN	8012667369033



Append.

HSS



INOX