

INDICADO PARA LA REGENERACIÓN DE ROSCAS O PARA OBTENER ROSCADOS MUY RESISTENTES EN MATERIALES BLANDOS.

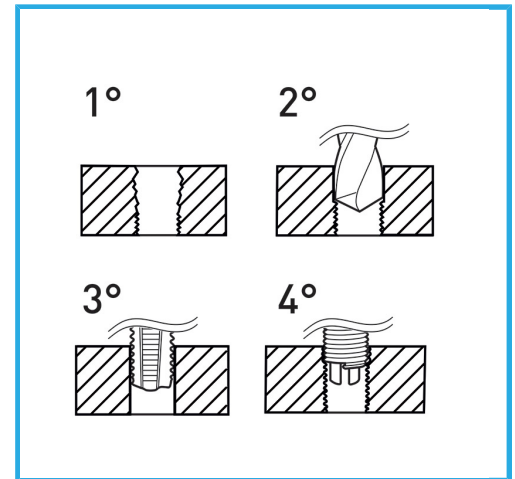

€50,80



<b>Rosca</b>	1/2" x 16
<b>Broca</b>	Ø 13.0 mm
<b>Machos STI</b>	E011/BSF1/2M
<b>Utensilio para insertar</b>	E011/U15
<b>Herr. rompe arrastre</b>	E011/A15
<b>Insertos roscados</b>	E010/BSF1/2E15
<b>Cantidad de insertos</b>	10
<b>Dimensiones de embalaje</b>	170x130x40 h mm
<b>Peso bruto</b>	0,66 kg
<b>Codigo de barras</b>	8012667363543



Colgante

HSS



INOX