

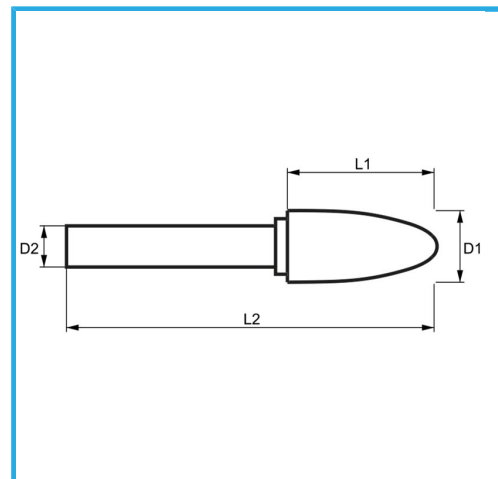

€4,67

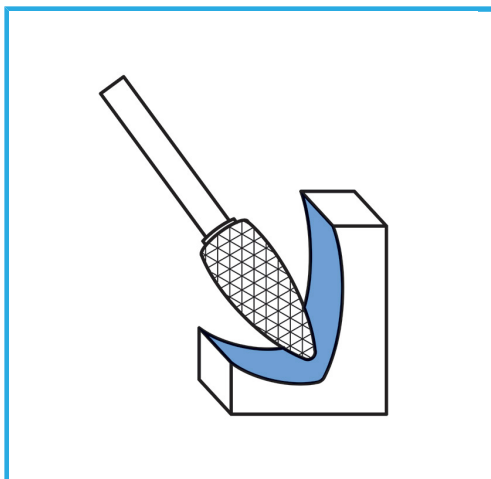

D1	ø3 mm
D2	13 mm
L1	3 mm
L2	38 mm
Peso lordo	0,01 kg
Dimensioni imballo	13 x 55 x 13 h mm
Codice EAN	8012667357412



Scatola



HM