

€15,10

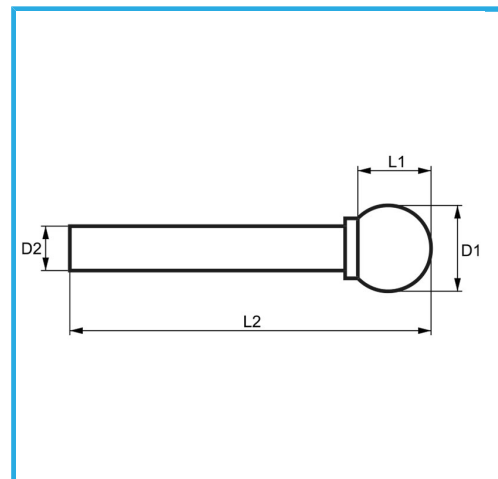

D1	ø10 mm
L1	9 mm
D2	6 mm
L2	54 mm
Dimensioni imballo	17 x 95 x 17 h mm
Peso lordo	0,02 kg
Codice EAN	8012667357115

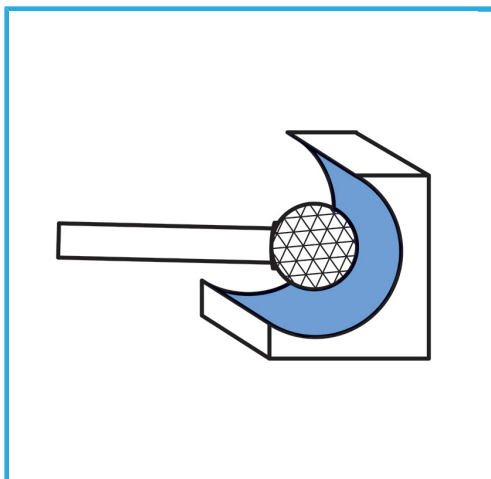

Scatola



HM